

Dong Cheng

PROFESSIONAL POWER TOOLS



2020
PRODUCT CATALOGUE

**KEEP
IMPROVING
UNCEASINGLY**



COMPANY PROFILE

Jiangsu Dongcheng M&E Tools Co., Ltd., is one of the key backbone enterprises manufacturing professional power tools in China with a high-class industrial production base. With modern plants, first-class production and testing equipments, Dongcheng company covers a construction area of 76,800 m². The company employs more than 3,200 staffs, including a management and R&D team composed of senior talents and engineers.

Dongcheng company manufactures various types of power tools and related spare parts, which are widely used in the fields of building construction, home decoration, stone industry, shipbuilding and water conservancy project. Sales network covers more than 50 countries and regions worldwide.

Quality ensurance and customer satisfaction are priorities of Dongcheng company. The company has passed the ISO9001:2015 quality management system certification. The whole process of quality assurance, from the inspection of raw materials and components to the safety inspection before the products leaving factory, is controlled by professional technicians.

Adhering to the mission of "Professional Power Tools, Keep Improving Unceasingly " and innovating constantly, Dongcheng company is striving for providing good quality products and good satisfying services to the global users.



CONTENTS



| | |
|---|-----------------------------|
|  | NEW/COMING SOON 01-07 |
|  | CORDLESS TOOLS 08-16 |
|  | ANGLE GRINDER 17-24 |
|  | POLISHER 24-25 |
|  | DIE GRINDER 25-26 |
|  | GRINDING POLISHER 26 |
|  | STRAIGHT GRINDER 26 |
|  | BENCH GRINDER 26-27 |
|  | DISK SANDER 27 |
|  | ORBITAL SANDER 27-29 |
|  | BELT SANDER 29 |
|  | DRYWALL SANDER 30 |
|  | MARBLE CUTTER 30-31 |
|  | GROOVE CUTTER 31-32 |

| | |
|---|--|
|  | ELECTRIC ROTARY HAMMER 32-33 |
|  | PERCUSSION HAMMER 34-35 |
|  | DIAMOND DRILL WITH WATER SOURCE .. 35-37 |
|  | ELECTRIC IMPACT DRILL 37-38 |
|  | ELECTRIC DRILL 38-41 |
|  | TAPPER 41 |
|  | MAGNETIC DRILL 41-42 |
|  | WELD JOINT BEVELLER 42 |
|  | ELECTRIC SHEAR 42 |
|  | ELECTRIC NIBBLER 42 |
|  | RECIPROCATING SAW 42 |
|  | ELECTRIC CUT-OFF MACHINE 43 |
|  | ELECTRIC MITRE SAW 44 |

COMMON FUNCTION SYMBOL INDEX



SDS-plus



SDS-max



Hex



CONSTANT SPEED

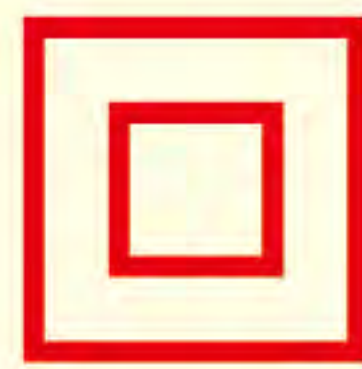

DOUBLE INSULATION

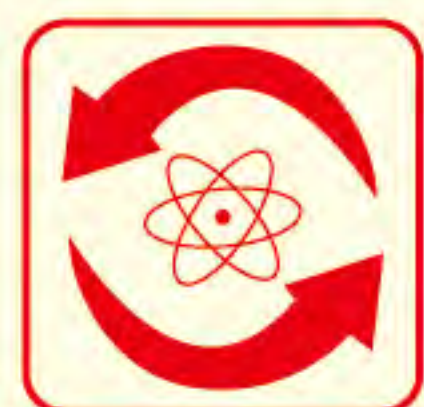

VARIABLE SPEED



F/R CONTROL

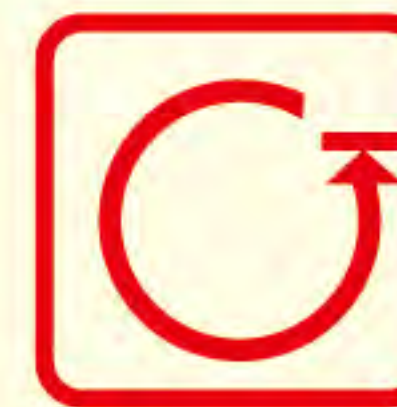

SMART LOOSEN FUNCTION



ELECTRIC PLANER 44-45



TRIMMER 45



WOOD ROUTER 46



MULTI-TOOL 46



JIG SAW 47



ELECTRIC CIRCULAR SAW 47-48



ELECTRIC CHAIN SAW 48



DUST-FREE SAW 49



SCREWDRIVER 49



IMPACT SCREWDRIVER 49



ELECTRIC WRENCH 49-50



SHEAR WRENCH 50



HEAT GUN 50-51



BLOWER VACUUM 51



VACUUM CLEANER 51-52



HIGH-PRESSURE WASHER 52



ELECTRIC MIXER 52-53



HIGH-PRESSURE SPRAYING UNIT 53



SPRAY GUN 54-55



AIR NAILER/STAPLER 56-57



AIR COMPRESSOR 57-58



LASER DISTANCE METER 59



GREEN LASER LEVEL 59-60



WELDING MACHINE 61



GENERATOR/GASOLINE WATER PUMP 62



GARDEN TOOLS 63-64

| Battery voltage | Battery capacity | Battery | Charger | Full charging time |
|-----------------|------------------|--|---|--------------------|
| 10.8V | 2.0 Ah |  LB1220-3 |  FFCL12-8 FFCL12-9 1.3A | ≈95 min |
| | |  LB1220-4 | | |
| 12V | 2.0 Ah |  LB1220-1 |  FFCL12-4 3.0A | ≈40 min |
| | 4.0 Ah |  LB1240-1 | | ≈80 min |
| 12V | 2.0 Ah |  LB1220-2 |  FFCL12-7 1.3A | ≈90 min |
| | | |  FFCL12-6 1.5A | ≈80 min |
| 14.4V | 2.0 Ah |  LB1420-1 |  FFCL14-1 2.0A | ≈60 min |
| 16V | 2.0 Ah |  LB1620-1 |  FFCL16-1 1.3A | ≈90 min |
| 18V | 2.0 Ah |  FFBL18-07 |  FFCL18-04 3.0A | ≈45 min |
| | 4.0 Ah |  FFBL18-02 FFBL18-03 | | ≈90 min |
| | 5.0 Ah |  FFBL18-04 FFBL18-06 | | ≈100 min |
| | 6.0 Ah |  FFBL18-05 | | ≈135 min |
| 20V | 2.0 Ah |  FFBL2020 |  FFCL20-02 2.0A | ≈60 min |
| | 4.0 Ah |  FFBL2040 | | ≈120 min |
| | 6.0 Ah |  FFBL2060 | | ≈180 min |

*Specifications may differ from country to country.

Dong Cheng

PROFESSIONAL POWER TOOLS



CORDLESS
IMPACT DRIVER
DCPL02-8



CORDLESS DRIVER DRILL
DCJZ09-10



CORDLESS DRIVER DRILL
DCJZ10-10



CORDLESS
DRIVER DRILL
DCJZ22-10



CORDLESS ROTARY
HAMMER
DCZC13



CORDLESS
CAULK GUN
DCPJ12



CORDLESS BRUSHLESS
DRIVER DRILL
DCJZ23-10



CORDLESS MULTI-TOOL
DCMD12

CORDLESS ANGLE
DRIVER DRILL
DCJZ14-10



CORDLESS BLIND
RIVETING GUN
DCPM40/DCPM50



CORDLESS RATCHET
WRENCH
DCPB02-10



CORDLESS
SABRE SAW
DCJF15



CORDLESS
DIE GRINDER
DCSJ10



12V
Lithium-Ion



12V 2.0Ah battery pack is applicable for all 12V series
12V 4.0Ah battery pack is not applicable for DCZC13

Dong Cheng

PROFESSIONAL POWER TOOLS



CORDLESS BRUSHLESS
ROTARY HAMMER
DCZC02-24



CORDLESS DRIVER/
HAMMER DRILL
DCJZ13



CORDLESS BRUSHLESS DRILL
DCJZ16



CORDLESS BRUSHLESS
IMPACT DRIVER
DCPL02-14



CORDLESS BRUSHLESS
IMPACT WRENCH
DCPB02-18



CORDLESS BRUSHLESS
ANGLE GRINDER
DCSM02-100/115/125



CORDLESS IMPACT WRENCH
DCPB20



CORDLESS AUTO
FEED SCREWDRIVER
DCPL6

CORDLESS RECIPROCATING SAW
DCJF28



BATTERY POWERED
PRUNING SHEARS
DCYD30

**18V
+18V**



CORDLESS BLOWER
DCQF28



18V
Lithium-Ion



18V 2.0Ah battery pack is only applicable for DCPL6A, DCPL02-14A, DCJZ13L
18V 4.0Ah, 5.0Ah and 6.0Ah battery packs are applicable for all 18V series

18V Lithium Battery Charge Technology



DongCheng charger communicates with the battery's built-in chip throughout the charging process to prolong battery life by actively controlling current and voltage

Over-discharge
Protection

Overcharge
Protection

Overload
Protection

Battery Protection Function

- With balanced charging function;
- Charge and discharge are controlled by communication protocol, ensuring high reliability;
- Battery pack with temperature on-board detection, more accurate than detected by external tools;
- Single cell detected independently;
- Preventing forged and fake commodity with encryption protocols.



**ANYTIME
CHARGE**

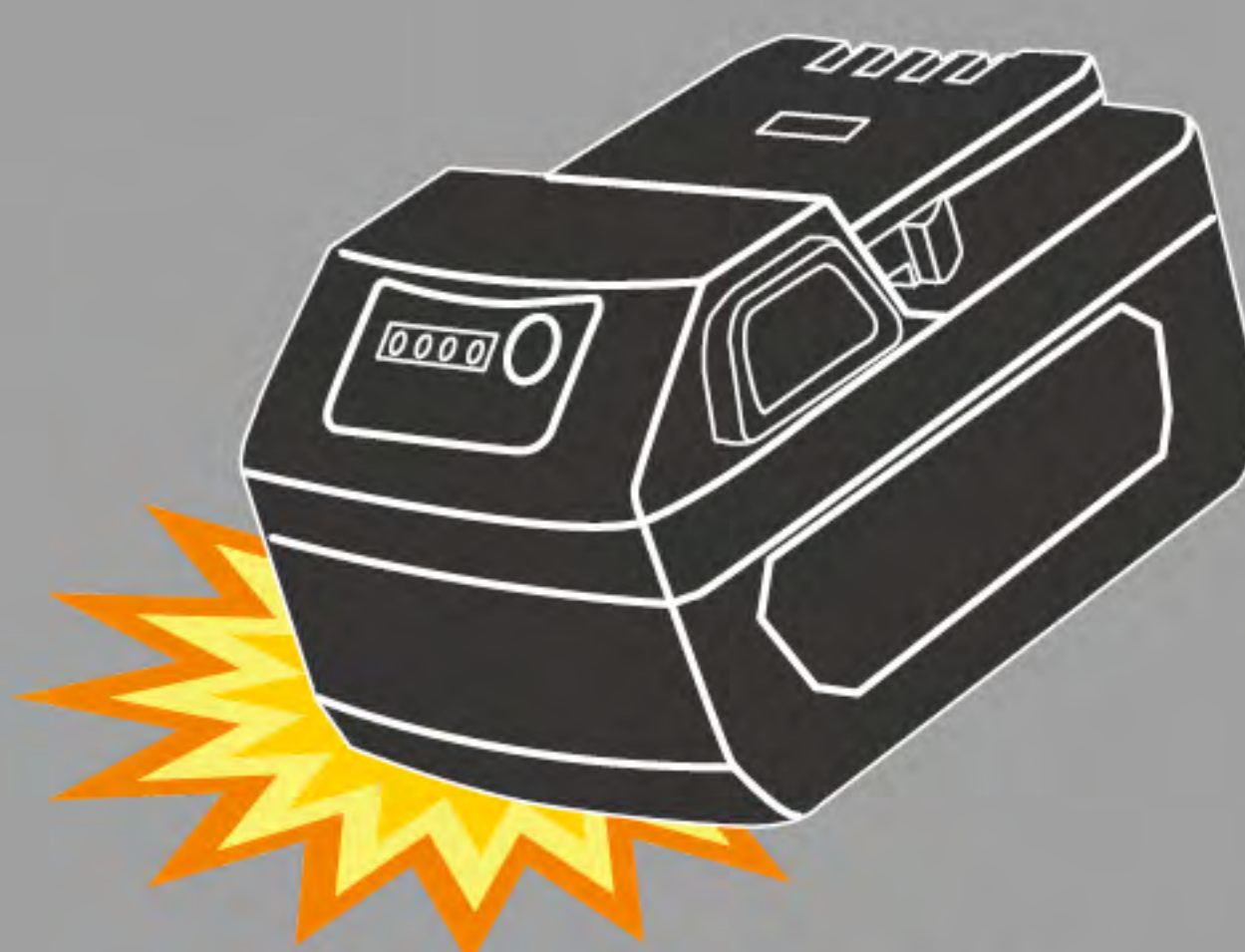

**SHOCK
ABSORBING**

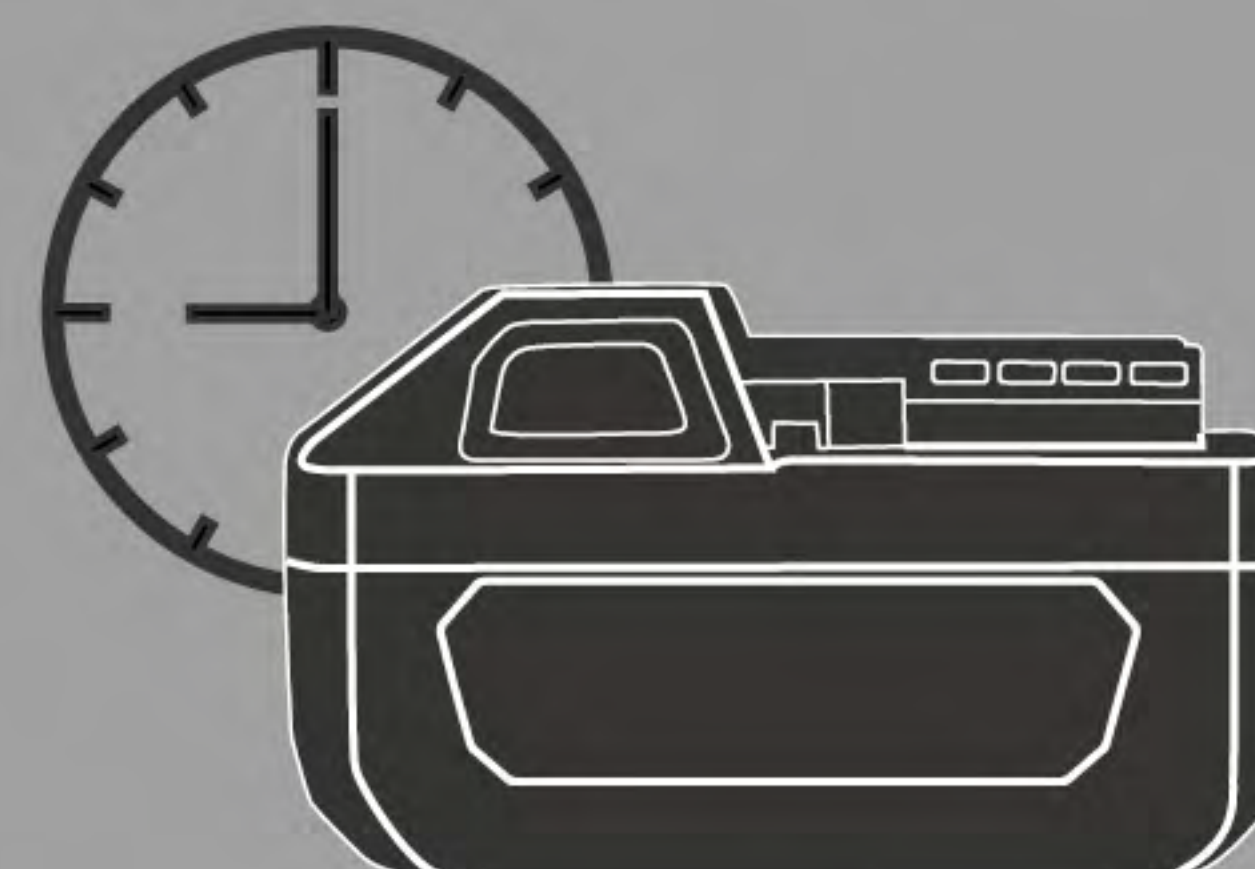

**LONGTIME
STORAGE**

Dong Cheng

PROFESSIONAL POWER TOOLS



CORDLESS BRUSHLESS DRIVER/
HAMMER DRILL
DCJZ03-13



CORDLESS BRUSHLESS
DRIVER DRILL
DCJZ04-13



CORDLESS BRUSHLESS DRIVER/
HAMMER DRILL
DCJZ05-13



CORDLESS BRUSHLESS
IMPACT WRENCH
DCPB298



CORDLESS BRUSHLESS ROTARY HAMMER
DCZC22



CORDLESS BRUSHLESS ANGLE GRINDER
DCSM03-100/115/125



CORDLESS
BRUSHLESS
HAMMER DRILL
DCZC04-24



CORDLESS BRUSHLESS PRUNER
DCYD25

CORDLESS BRUSHLESS
CIRCULAR SAW
DCMY185

CORDLESS BRUSHLESS
CIRCULAR SAW
DCMY165



20V
Lithium-Ion



20V 2.0Ah battery pack is only applicable for DCYD25, DCJZ04-13, DCJZ05-13
20V 4.0Ah and 6.0Ah battery packs are applicable for all 20V series

DURABLE SPECIALLY for 20V lithium batteries



BATTERY SLIDE

Firmly connect batteries and tools for high intensity work



REINFORCED PROTECTIVE WALL

Effectively extend the service life of the terminal

LOCK WITH ONE FINGER

UNIT CELL

NICKEL PLATE

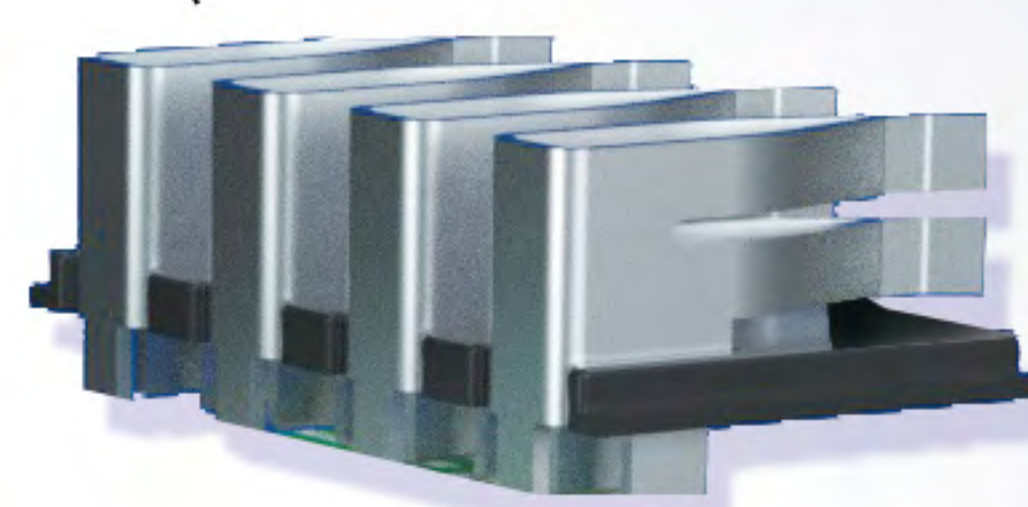

PROTECTIVE BARRIER

Effectively prevent dust from entering the battery pack



SEALING SILICONE

Effectively protect the chip from dust or metal damage



BATTERY INDICATOR



STURDY HOUSING AND BATTERY PROTECTION BRACKET

Good vibration resistance can, can effectively alleviate the damage of external shock to the battery



20V 2.0Ah



20V 4.0Ah



20V 6.0Ah

*Specifications may differ from country to country.

New/Coming soon

New

NEW PRODUCTS COMING SOON



DCPB02-10(TYPE E/EK/Z)

CORDLESS RATCHET WRENCH

New
COMING
SOON



Li-ion 12V  

Features

1. Easy to operate in a narrow space;
2. 45N.m high torque output;
3. Adjustable speed, match various applications.

Accessories & Package

Battery Charger, 2.0Ah Battery Pack (2pcs),
Square Drive Adapter, Socket S15,
Plastic Case Packing

(Type EK) Economical model
(Type Z) Solo, Color Box Packing

| | |
|-------------------|------------------|
| Battery | 12V/2.0Ahx2/Solo |
| No-load Speed | 0-500r/min |
| Max. Torque | 45N·m |
| Square Drive Size | 3/8" |
| Net Weight | 0.9kg |

DCJZ23-10(TYPE E/EK/Z)

CORDLESS BRUSHLESS DRIVER DRILL

New
COMING SOON

EC
BRUSHLESS
MOTOR



Li-ion 12V

Features

1. Brushless motor, more powerful, higher efficiency and longer runtime and lifetime;
2. Ultra-compact body, more comfortable to hold;
3. 35N.m, high torque output;
4. 20+1 torque setting, multi-function;

Accessories & Package

Battery Charger, 2.0Ah Battery Pack (2pcs), Driver Bit, Plastic Case Packing

(Type EK) Economical model
(Type Z) Solo, Color Box Packing

| | |
|------------------------|---|
| Battery | 12V/2.0Ah×2/Solo |
| Max. Chucking Capacity | 10mm |
| Max. Screw Dia. | 7mm |
| No-load Speed | 1st gear 0-460r/min 2nd gear 0-1600r/min |
| Max. Drilling Dia. | Steel Φ10mm Wood Φ20mm |
| Torque Setting | 20+1 |
| Max. Torque | 1st gear 35N·m 2nd gear 16N·m |
| Net Weight | 0.93kg |

New/Coming soon

DCJZ24-10(TYPE EM)

CORDLESS BRUSHLESS DRIVER DRILL

New
COMING SOON

EC
BRUSHLESS
MOTOR



Li-ion 14.4V

Features

1. Brushless motor, more powerful, higher efficiency and longer runtime and lifetime;
2. Ultra-compact body, more comfortable to hold;
3. 40N·m, high torque output;
4. 20+1 torque setting, multi-function.

Accessories & Package

Battery Charger, 2.0Ah Battery Pack (2pcs), Driver Bit, Plastic Case Packing

(Type EM) Economical model

| | |
|------------------------|---|
| Battery | 14.4V/2.0Ah×2 |
| Max. Chucking Capacity | 10mm |
| Max. Screw Dia. | 7mm |
| No-load Speed | 1st gear 0-480r/min 2nd gear 0-1600r/min |
| Max. Drilling Dia. | Steel Φ10mm Wood Φ20mm |
| Torque Setting | 20+1 |
| Max. Torque | 1st gear 40N·m 2nd gear 20N·m |
| Net Weight | 1.07kg |

DCJZ1602(TYPE E)

CORDLESS DRIVER DRILL

New
COMING SOON



Li-ion 16V

Features

1. Economical model, 16V new battery pack platform;
2. 38N·m, high torque output;
3. 18+1 torque setting, multi-function;
4. 2-speed, meet different working requirements;
5. Rubber-covered handle, anti-vibration and anti-slip, comfortable for gripping.

Accessories & Package

Battery Charger, 2.0Ah Battery Pack (2pcs), Driver Bit, Plastic Case Packing

| | |
|------------------------|---|
| Battery | 16V/2.0Ah×2 |
| Max. Chucking Capacity | 10mm |
| Max. Screw Dia. | 7mm |
| No-load Speed | 1st gear 0-400r/min 2nd gear 0-1500r/min |
| Max. Drilling Dia. | Steel Φ10mm Wood Φ22mm |
| Torque Setting | 18+1 |
| Max. Torque | 1st gear 38N·m 2nd gear 25N·m |
| Net Weight | 1.05kg |

DCMY165(TYPE BM/Z)

CORDLESS BRUSHLESS CIRCULAR SAW

New
COMING SOON

EC
BRUSHLESS
MOTOR



Li-ion 20V

Features

1. Brushless motor, more powerful, higher efficiency and longer runtime and lifetime;
2. Ultra-compact body, easy to carry and comfortable to hold;
3. Outer armature structure design, greater cutting force;
4. Adjustable 0-50° bevel cutting angle, meet different cutting requirements.

Accessories & Package

Battery Charger, 2.0Ah Battery Pack (2pcs), Hex Wrench 5, Fixing Plate, Operation Instructions, Color Box Packing

(Type BM) Economical model
(Type Z) Solo, Color Box Packing

| | |
|-----------------------|------------------|
| Battery | 20V/4.0Ah×2/Solo |
| No-load Speed | 5000r/min |
| Blade Dia. | 165mm |
| Max. Cutting Capacity | 0° 59mm |
| Max. Cutting Angle | 50° |
| Net Weight | 3.8kg |

DCZC04-24(TYPE EM/Z)

CORDLESS BRUSHLESS HAMMER DRILL



Li-ion 20V

Features

1. Brushless motor, greater power, higher efficiency and longer runtime and lifetime;
2. 3-Mode operation, drill, rotary hammer and demolition;
3. Electronic constant speed control, maintains constant speed under load;
4. Mechanical and electronic clutch design, double safety protection.

Accessories & Package

Battery Charger, 4.0Ah Battery Pack (2pcs), Auxiliary Handle, Depth Gauge, Plastic Case Packing

(Type EM) Economical model
(Type Z) Solo, Color Box Packing

| | |
|------------------------|------------------|
| Battery | 20V/4.0Ahx2/Solo |
| Max. Drilling Capacity | |
| Concrete | Φ24mm |
| Steel | Φ13mm |
| Wood | Φ28mm |
| Rated Impact Frequency | 0-4500/min |
| No-load Speed | 0-1000r/min |
| Net Weight | 3.2kg |

DCPB298(TYPE BM/Z)

CORDLESS BRUSHLESS IMPACT WRENCH



Li-ion 20V

Features

1. Brushless motor, greater power, higher efficiency and longer runtime and lifetime;
2. 2-speed, match various applications;
3. Smart loosen function, effectively solve the safety problem when working at height;
4. Ergonomic body design, more compact structure and more comfortable grip.

Accessories & Package

Battery Charger, 4.0Ah Battery Pack (2pcs), Sockets S22, Suspension Strap, Tool Carrying Bag, Plastic Case Packing

(Type BM) Economical model
(Type Z) Solo, Color Box Packing

| | |
|------------------------|------------------|
| Battery | 20V/4.0Ahx2/Solo |
| Standard Bolt Size | M12-M16mm |
| Square Drive Size | 12.7mm(1/2") |
| Torque Setting | Smart-loosen |
| Step L | 210N·m |
| Step H | 298N·m |
| No-load Speed | 0-2000r/min |
| Rated Impact Frequency | 0-3000/min |
| Net Weight | 1.7kg |

DCYD25(TYPE BM/Z)

CORDLESS BRUSHLESS PRUNER



Li-ion 20V

Features

1. Brushless motor, greater power, higher efficiency and longer runtime and lifetime;
2. Dual safety switch, effectively avoid false start;
3. Quick blade replacement, more convenient and fast;
4. Ergonomic body design, compact structure for a comfortable grip.

Accessories & Package

Battery Charger, 2.0Ah Battery Pack (2pcs), Wrench 13, Hex Wrench 4, Whetstone, Lubricating oil, Tool Carrying Bag, Operation Instructions, Color Box Packing

(Type BM) Economical model
(Type Z) Solo, Color Box Packing

| | |
|-------------------|------------------|
| Battery | 20V/2.0Ahx2/Solo |
| Shearing Capacity | |
| Dry Branch | Φ20mm |
| Wet Branch | Φ25mm |
| Net Weight | 1.2kg |

DSM08-100S

ANGLE GRINDER

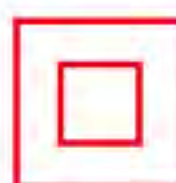

Features

1. Upgrade model from DSM08-100, higher power, higher efficiency and longer lifetime;
2. High strength gears, more durable;
3. Compact gear housing design, easy to use in narrow and confined areas;
4. Auto stop carbon brush, effectively extend the lifetime of motor.

Accessories & Package

Wrench, Carbon Brush, Color Box Packing

| | |
|--------------------|------------|
| Rated Power Input | 1010W |
| Rated Speed | 13000r/min |
| Max. Wheel Dia. | Φ100mm |
| Hole Dia. of Wheel | Φ16mm |
| Net Weight | 1.7kg |

DSM17-100

ANGLE GRINDER

New
COMING SOON

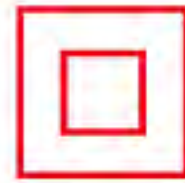

Features

1. New energy-gathering motor, more efficient and higher overload resistance;
2. High strength gears, more durable;
3. Ultra-slim body, more comfortable to hold;
4. Detachable dustproof net, more convenient for cleaning;
5. Auto stop carbon brush, effectively extend the lifetime of motor.

Accessories & Package

Wrench, Carbon Brush, Color Box Packing

| | |
|--------------------|------------|
| Rated Power Input | 1100W |
| Rated Speed | 13000r/min |
| Max. Wheel Dia. | Φ100mm |
| Hole Dia. of Wheel | Φ16mm |
| Net Weight | 1.6kg |

New/Coming soon

DSM06-180/DSM06-230

ANGLE GRINDER

New
COMING SOON

Soft Start Optional / With Soft Start

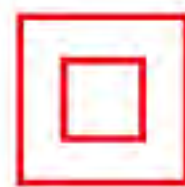

Features

1. Labyrinth dustproof structure, effectively extend the lifetime of product;
2. Auto stop carbon brush, effectively extend the lifetime of motor;
3. Rubber-covered handle, more comfortable to hold;
4. Spindle lock, Large trigger switch.

Accessories & Package

Auxiliary Handle, Wrench, Carbon Brush, Color Box Packing

| | |
|--------------------|----------------|
| Rated Power Input | 2100W |
| Rated Speed | 8300/6600r/min |
| Max. Wheel Dia. | Φ180/Φ230mm |
| Hole Dia. of Wheel | Φ22mm |
| Net Weight | 5.0kg |

DSF02-180

DRYWALL SANDER

New
COMING SOON



Features

1. LED double light strip, 360° no dead zone;
2. Self-vacuum function, effectively purify the operating environment;
3. Adjustable speed, match various applications.

Accessories & Package

Auxiliary Handle, Dust Cleaning Hose Assembly, Dust Bag, Cannulate Sockolet, Abrasive Paper Assembly, Carbon Brush, Color Box Packing

| | |
|--------------------|----------------|
| Rated Power Input | 750W |
| No-load Speed | 1500-2700r/min |
| Grinding Disc Dia. | Φ180mm |
| Net Weight | 2.3kg |

DZE110S

MARBLE CUTTER

New
COMING SOON



Features

1. Power upgrade from 1200W(DZE110) to 1400W, higher cutting efficiency;
2. Anti-splash board design, effectively optimizing the operating environment;
3. Labyrinth dustproof structure.

Accessories & Package

Socket Wrench, Wrench, Carbon Brush, Color Box Packing

| | |
|-----------------------|------------|
| Rated Power Input | 1400W |
| Blade Dia. | Φ110mm |
| Max. Cutting Capacity | 30mm |
| No-load Speed | 13000r/min |
| Net Weight | 2.9kg |

DZC07-26

ELECTRIC ROTARY HAMMER



SDS plus



Features

1. Single function: rotary hammer;
2. New safety release clutch, effectively protect the safety of operators;
3. Multiple vibration absorbing system, effectively reduce operator fatigue;
4. Large trigger switch, SDS-PLUS.

Accessories & Package

Auxiliary Handle, Dust Cap, Oiler, Carbon Brush, Plastic Case Packing

| | |
|---------------------------------|-----------|
| Rated Power Input | 1010W |
| No-load Speed | 1250r/min |
| Rated Impact Frequency | 4750/min |
| Max. Drilling Capacity Concrete | Φ26mm |
| Net Weight | 3.9kg |

DZC03-38S

ELECTRIC ROTARY HAMMER



Hex 13mm



Features

1. Safety clutch design, effectively protect the safety of the operator;
2. 2-Mode operation, rotary hammer and demolition;
3. High-strength metal shell design, for heavy-duty applications;
4. High efficient anti-vibration system, effectively reduce operator fatigue.

Accessories & Package

Drill Bit (Hex 13mm), Auxiliary Handle, Carbon Brush, Operation Instructions, Plastic Case Packing

| | |
|---------------------------------|----------|
| Rated Power Input | 1100W |
| No-load Speed | 320r/min |
| Rated Impact Frequency | 2900/min |
| Max. Drilling Capacity Concrete | Φ38mm |
| Net Weight | 6.2kg |



Hammer & Demolition

DZG06-6S

PERCUSSION HAMMER



Hex 17mm



Features

1. 1400W super power;
2. Newly upgraded vibration absorbing system, effectively reduce operator fatigue;
3. 35mm diameter cylinder, double efficiency of destructive power compared with 30mm diameter.

Accessories & Package

Grease, Auxiliary Handle, Special Wrench, Carbon Brush, Plastic Case Packing

| | |
|------------------------|----------|
| Rated Power Input | 1400W |
| Rated Impact Frequency | 3900/min |
| Net Weight | 6.8kg |

DZG16

PERCUSSION HAMMER



Hex 30mm



Features

1. 1700W surging power, higher destructive power;
2. Effectively vibration control system, reduce harmful vibration.

Accessories & Package

Grease, Auxiliary Handle, Hex Wrench, Carbon Brush, Plastic Case Packing

| | |
|------------------------|----------|
| Rated Power Input | 1700W |
| Rated Impact Frequency | 1300/min |
| Net Weight | 18.8kg |

DZZ168

DIAMOND DRILL WITH WATER SOURCE

New
COMING SOON



Features

1. Economical model;
2. Dual-use, handheld and vertical type;
3. Safety clutch design, effectively protect the safety of operators.

Accessories & Package

Auxiliary Handle, Pipe Connector, Rear Bracket, Operation Instructions, Plastic Case Packing

| | |
|-----------------------------------|-------------|
| Rated Power Input | 2000W |
| No-load Speed | 0-1920r/min |
| Max.Drilling Capacity Concrete | Φ102mm |
| Brick wall | Φ168mm |
| Net Weight | 5.8kg |

New/Coming soon

DZZ04-200

DIAMOND DRILL WITH WATER SOURCE

New
COMING SOON



Features

1. Economical model;
2. 3200W super power, high drilling efficiency;
3. Safety clutch design, effectively protect the safety of operators;
4. Double handle design, more convenient to carry;
5. Thickened bracket base for high stability.

Accessories & Package

Pipe Connector, Hex Wrench 6, Hex Wrench 5, Hex Wrench 4, Operation Instructions, Carton Packing

| | |
|-----------------------|----------|
| Rated Power Input | 3200W |
| No-load Speed | 900r/min |
| Max.Drilling Capacity | Φ200mm |
| Net Weight | 18.1kg |

DJC32

MAGNETIC DRILL

New
COMING SOON



Features

1. Electronic constant speed control, maintains constant speed under load;
2. Soft start function, smoothly start-ups;
3. 2-speed gear box and 5-speed electronic speed adjustment, match various applications;
4. Overload protection, safety release clutch, effectively protect the safety of operators.

Accessories & Package

Wedge Iron, Safety Belt, Hex Wrench (4pcs), Extension Rod for Morse Taper Bush with Tang (MT3-B16), Core Drill Bit Joint Assembly, Drill Chuck, Chuck Wrench, Center Pin, Long Center Pin, Short center pin, Morse Reduction Sleeve(MT3-2), Oiler Assembly, Carbon Brush, Plastic Case Packing

| | |
|---|--------------------------------|
| Rated Power Input | 2000W |
| No-load Speed | 60-120/85-170/ 190-380r/min |
| Max. Drilling Capacity Twist Drill Bit | Φ32mm |
| Core Drill Bit | Φ100mm |
| Max.Tapping Capacity | M30 |
| Max. Stroke | 255mm |
| Magnetism | 20000N |
| Connector | Mt3 Shank |
| Net Weight | 27.0kg |

DJF02-30

RECIPROCATING SAW

New
COMING SOON



Features

1. 1300W super power, higher cutting efficiency;
2. Ergonomic body design, effectively reduce operator fatigue;
3. SDS quick change system, faster blade replacement;
4. Adjustable depth and angle base design, suitable for various cutting needs.

Accessories & Package

Saw Blade (Wood), Saw Blade(Iron), Carbon Brush, Plastic Case Packing

| | |
|--------------------------------|------------|
| Rated Power Input | 1300W |
| No-load Strokes | 0-2900/min |
| Length of Strokes | 30mm |
| Max. Cutting Capacity Steel | 130mm |
| Wood | 255mm |
| Net Weight | 3.8kg |

DMR06-12

WOOD ROUTER

New
COMING SOON



Features

1. Combines high power and high precision, match the most demanding routing applications;
2. Electronic constant speed control, maintains constant speed under load;
3. Adjustable speed, match various applications.
4. Soft start function, smoothly start-ups;
5. Built-in fan of labyrinth structure, effectively reduce dust entering the tool, prolong the tool's service life.

Accessories & Package

Wrench (2pcs), Straight Guide, Retainer Base Assembly, Templet Guide, Trimmer Guide Assembly, Invert Adjustment Screw, Collet (6.35mm), Collet (9.52mm), Carbon Brush, Color Box Packing

| | |
|--------------------------|-----------------|
| Rated Power Input | 2000W |
| No-load Speed | 9000-22000r/min |
| Max. Milling Cutter Dia. | Φ12.7mm |
| Net Weight | 4.6kg |

DMY04-185

ELECTRIC CIRCULAR SAW

New
COMING SOON

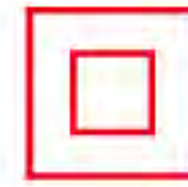

Features

1. High-quality aluminum guard, greatly reducing product weight;
2. Rigid aluminum base for fine cut;
3. Improved internal air path design, backward dust emission.

Accessories & Package

Hex Wrench, Fixing Plate, Carbon Brush, Color Box Packing

| | |
|-----------------------|-----------|
| Rated Power Input | 1100W |
| No-load Speed | 6000r/min |
| Blade Dia. | 185mm |
| Max. Cutting Capacity | 68mm |
| Max. Cutting Angle | 45° |
| Net Weight | 3.4kg |

DQF120

BLOWER VACUUM

New
COMING SOON



Features

1. Industrial-grade blower;
2. Max. air speed: 55m/s, strong wind;
3. Widely used, such as dust removal, snow blowing, leaf blowing, etc;
4. Can be matched with shoulder strap, effectively reduce hand fatigue;
5. 5-gear adjustable air speed, match various applications;

Accessories & Package

Hanging Buckle, Suspension Strap, Operation Instructions, Color Box Packing

| | |
|-------------------|-----------------|
| Rated Power Input | 1200W |
| No-load Speed | 8000-17000r/min |
| Air Volume | 7.2-12m³/min |
| Air Speed | 32-55m/s |
| Net Weight | 2.9kg |

DVC12

VACUUM CLEANER

New
COMING SOON

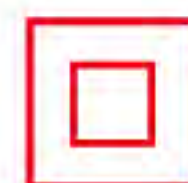

Features

1. Small size, suitable for home use;
2. Equipped with a variety of brush assemblies, match various applications;
3. 18kPa Max. Vacuum Pressure, Strong suction power;
4. Waterproof level: IPX4.

Accessories & Package

Universal Wheel, Small Brush Assembly, Floor Brush Assembly, Telescopic Steel Pipe, Outlet Filter, Vacuum Hose Assembly, Operation Instructions, Carton Packing

| | |
|----------------------|---------|
| Rated Power Input | 1200W |
| Capacity | 10L |
| Max. Vacuum Pressure | 18kPa |
| Max. Air Volume | 26L/s |
| Cooling System | Recycle |
| Net Weight | 4.0kg |

Dong Cheng



DCPL 5(TYPE C)**4V****CORDLESS SCREWDRIVER**

| | |
|-----------------------|------------|
| Battery | 4V/2.0Ah |
| Clamping Capacity | 6.35mm Hex |
| Max. Screw Dia. | 5mm |
| No-load Speed | 200r/min |
| Max. Fastening Torque | 4N·m |
| Net Weight | 0.35kg |

**Features**

Small and compact, Cable charger.

Accessories & Package

Cable Charger, Driver Bits Set, Reducing Sleeve, Blister Packing

DCPL 02-5(TYPE B)**4V****CORDLESS SCREWDRIVER**

| | |
|-----------------------|------------|
| Battery | 4V/2.0Ah |
| Clamping Capacity | 6.35mm Hex |
| Max. Screw Dia. | 5mm |
| No-load Speed | 200r/min |
| Max. Fastening Torque | 4N·m |
| Net Weight | 0.35kg |

**Features**

Small and compact, Bracket charger.

Accessories & Package

Bracket Charger, Driver Bits Set, Long Cross Driver Bit, Reducing Sleeve, Color Box Packing

DCPL03-5(TYPE E)**4V****CORDLESS SCREWDRIVER**

| | |
|-------------------|------------|
| Battery | 4V/2.0Ah |
| Clamping Capacity | 6.35mm Hex |
| Max. Screw Dia. | 5mm |
| Max. Torque | 5N·m |
| No-load Speed | 240r/min |
| Torque Setting | 3(1-2-3) |
| Net Weight | 0.28kg |

**Features**

1. Small and compact, 3-Gear torque adjustment;
2. Multiple functions: Wire Stripping, Electricity inspecting, etc.

Accessories & Package

USB Cable, Driver Bits Set, Long Driver Bit Set, Reducing Sleeve, Plastic Case Packing

DCJZ1202(TYPE E)**10.8V****CORDLESS DRIVER DRILL**

| | |
|------------------------|------------------------------------|
| Battery | 10.8V/2.0Ah×2 |
| Max. Chucking Capacity | 10mm |
| No-load Speed | Low 0-400r/min High 0-1500r/min |
| Max. Drilling Dia. | Steel Φ10mm Wood Φ22mm |
| Torque Setting | 18+1 |
| Max. Torque | 35N·m |
| Net Weight | 1.0kg |

**Features**

1. Economical model, New battery pack platform;
2. 2-Speed, 35N.m high torque.

Accessories & Package

Battery Charger, 2.0Ah Battery Pack (2pcs), Double-end Driver Bit, Plastic Case Packing

DCJZ6(TYPE B)**12V****CORDLESS DRIVER DRILL**

| | |
|------------------------|--------------------------|
| Battery | 12V/2.0Ah |
| Max. Chucking Capacity | 6mm |
| Max. Screw Dia. | 6mm |
| No-load Speed | 0-700r/min |
| Max. Drilling Capacity | Steel Φ6mm Wood Φ12mm |
| Max. Torque | 15N·m |
| Net Weight | 0.9kg |

**Features**

1. Economical model, Internal battery;
2. Equipped with power adapter.

Accessories & Package

Cable Charger, Driver Bit, Color Box Packing

DCJZ09-10(TYPE B/BK/Z)**12V****CORDLESS DRIVER DRILL**

| | |
|------------------------|---------------------------|
| Battery | 12V/2.0Ahx1/Solo |
| Max. Chucking Capacity | 10mm |
| Max. Screw Dia. | 7mm |
| No-load Speed | 0-700r/min |
| Max. Drilling Capacity | Steel Φ10mm Wood Φ20mm |
| Torque Setting | 16+1 |
| Max. Torque | 25N·m |
| Net Weight | 1.0kg |



(Type BK) Economical model
(Type Z) Solo, Color Box Packing

Features

Adjustable speed, LED light, Forward and reverse rotation.

Accessories & Package

Battery Charger, 2.0Ah Battery Pack, Driver Bit, Color Box Packing

DCJZ09-10(TYPE E/EK)

12V

CORDLESS DRIVER DRILL



| | |
|------------------------|---------------------------------------|
| Battery | 12V/2.0Ahx2 |
| Max. Chucking Capacity | 10mm |
| Max. Screw Dia. | 7mm |
| No-load Speed | 0-700r/min |
| Max. Drilling Capacity | Steel Φ 10mm Wood Φ 20mm |
| Torque Setting | 16+1 |
| Max. Torque | 25N·m |
| Net Weight | 1.0kg |



(Type EK) Economical model

Features

Adjustable speed, LED light, Forward and reverse rotation.

Accessories & Package

Battery Charger, 2.0Ah Battery Pack (2pcs), Driver Bit, Plastic Case Packing

DCJZ10-10(TYPE B/BK/Z)

12V

CORDLESS DRIVER DRILL



| | |
|------------------------|---------------------------------------|
| Battery | 12V/2.0Ahx2/Solo |
| Max. Chucking Capacity | 10mm |
| Max. Screw Dia. | 7mm |
| No-load Speed | Step1 0-400r/min Step2 0-1500r/min |
| Max. Drilling Capacity | Steel Φ 10mm Wood Φ 20mm |
| Torque Setting | 16+1 |
| Max. Torque | 30N·m |
| Net Weight | 1.1kg |



(Type BK) Economical model
(Type Z) Solo, Color Box Packing

Features

2-Speed, LED light, Forward and reverse rotation.

Accessories & Package

Battery Charger, 2.0Ah Battery Pack (2pcs), Driver Bit, Tool Carrying Bag, Color Box Packing

DCJZ10-10(TYPE E/EK)

12V

CORDLESS DRIVER DRILL



| | |
|------------------------|---------------------------------------|
| Battery | 12V/2.0Ahx2 |
| Max. Chucking Capacity | 10mm |
| Max. Screw Dia. | 7mm |
| No-load Speed | Step1 0-400r/min Step2 0-1500r/min |
| Max. Drilling Capacity | Steel Φ 10mm Wood Φ 20mm |
| Torque Setting | 16+1 |
| Max. Torque | 30N·m |
| Net Weight | 1.1kg |



(Type EK) Economical model

Features

2-Speed, LED light, Forward and reverse rotation.

Accessories & Package

Battery Charger, 2.0Ah Battery Pack (2pcs), Driver Bit, Plastic Case Packing.

DCJZ14-10(TYPE E/EK/Z)

12V

CORDLESS ANGLE DRIVER DRILL



| | |
|------------------------|---------------------------------------|
| Battery | 12V/2.0Ahx2/Solo |
| Max. Chucking Capacity | 10mm |
| Max. Screw Dia. | 6.5mm |
| No-load Speed | 0-800r/min |
| Max. Drilling Capacity | Steel Φ 10mm Wood Φ 25mm |
| Max. Torque | 11N·m |
| Net Weight | 1.0kg |



(Type EK) Economical model
(Type Z) Solo, Color Box Packing

Features

1. Angular design, Easy to use in narrow space;
2. Adjustable speed, LED light.

Accessories & Package

Battery Charger, 2.0Ah Battery Pack (2pcs), Plastic Case Packing.

DCJZ22-10(TYPE E/EK/Z)

12V

CORDLESS DRIVER DRILL



| | |
|------------------------|---------------------------------------|
| Battery | 12V/2.0Ahx2/Solo |
| Max. Chucking Capacity | 10mm |
| Max. Screw Dia. | 7mm |
| No-load Speed | Step1 0-380r/min Step2 0-1300r/min |
| Max. Drilling Capacity | Steel Φ 10mm Wood Φ 20mm |
| Torque Setting | 20+1 |
| Max. Torque | 32N·m |
| Net Weight | 1.0kg |



(Type EK) Economical model
(Type Z) Solo, Color Box Packing

Features

1. Ultra compact body;
2. 2-Speed, LED light;
3. Forward and reverse rotation.

Accessories & Package

Battery Charger, 2.0Ah Battery Pack (2pcs), Driver Bit, Plastic Case Packing.

DCPL02-8(TYPE E/EK/Z)

12V

CORDLESS IMPACT DRIVER



| | |
|-----------------------|------------------|
| Battery | 12V/2.0Ahx2/Solo |
| Standard Bolt Size | M5-M12mm |
| Clamping Capacity | 6.35mm Hex |
| Coarse Screw Length | 22-90mm |
| No-load Speed | 0-2400r/min |
| Rated Impacts | 0-3000/min |
| Max. Fastening Torque | 100N·m |
| Net Weight | 1.0kg |



(Type EK) Economical model
(Type Z) Solo, Color Box Packing

Features

Adjustable speed, Forward and reverse rotation.

Accessories & Package

Battery Charger, 2.0Ah Battery Pack (2pcs), Driver Bit, Plastic Case Packing

DCZC13(TYPE B/BK/Z)**12V+****CORDLESS ROTARY HAMMER**

| | |
|------------------------|----------------------|
| Battery | 12V/2.0Ahx2/Solo |
| Max. Drilling Capacity | Steel Φ 8mm |
| | Wood Φ 10mm |
| | Concrete Φ 12mm |
| Rated Impact Frequency | 0-5600/min |
| No-load Speed | 0-900r/min |
| Net Weight | 1.3kg |



(Type BK) Economical model
(Type Z) Solo, Color Box Packing

Features

1. 3-Mode operation, screwdriver, drill and rotary hammer;
2. SDS-PLUS quick change chuck;
3. Adjustable speed, LED light, Forward and reverse rotation.

Accessories & Package

Battery Charger, 2.0Ah Battery Pack (2pcs), Drill Chuck, Driver Bit, Twist Drill Bit, SDS-Plus Hammer Drill Bit, Color Box Packing

DCMD12(TYPE E/EK/Z)**12V+****CORDLESS MULTI-TOOL**

| | |
|------------------------|------------------|
| Battery | 12V/2.0Ahx2/Solo |
| Oscillations Frequency | 5000-20000/min |
| Speed Shifting Gears | 2-4-6-8-10-12 |
| Oscillation Angle | 3° |
| Power Display | 3 |
| Net Weight | 0.95kg |



(Type EK) Economical model
(Type Z) Solo, Color Box Packing

Features

1. 6-Speed, Match different accessories, widely applications.

Accessories & Package

Battery Charger, 2.0Ah Battery Pack (2pcs), Adaptor for Tool Holder, Cut Saw Blade (2pcs), Segment Saw Blade, Scraper, Sanding Plate, Abrasive Paper (12pcs), Hex Wrench, Plastic Case Packing

DCPM40(TYPE E/EK/Z)**12V+****CORDLESS BLIND RIVETING GUN**

| | |
|--------------|---|
| Battery | 12V/2.0Ahx2/Solo |
| Stroke | 20mm |
| Capacity | Φ 2.4- Φ 4.0 For All-purpose |
| | Φ 2.4- Φ 5.0 For Aluminum Blind Rivet, Pull the nail fast |
| Max. Tension | 7000N |
| Net Weight | 1.6kg |



(Type EK) Economical model
(Type Z) Solo, Color Box Packing

Features

1. Pulling rivets faster;
2. Φ 2.4- Φ 4.0 for all-purpose.

Accessories & Package

Battery Charger, 2.0Ah Battery Pack (2pcs), Nosepiece (4pcs), Mandrel Part (2pcs), Magnetic Ring, Wrench, Plastic Case Packing

DCSJ10(TYPE E/EK/Z)**12V+****CORDLESS DIE GRINDER**

| | |
|--------------------------|------------------|
| Battery | 12V/2.0Ahx2/Solo |
| No-load Speed | 5000-32000r/min |
| Speed Shifting Gears | 1-2-3-4-5-6 |
| Max. Collect Size | Φ 3.2mm |
| Max. Grinding Wheel Dia. | 10mm |
| Power Display | 3 |
| Net Weight | 0.61kg |



(Type EK) Economical model
(Type Z) Solo, Color Box Packing

Features

1. 6-Speed, Rubber-covered body.

Accessories & Package

Battery Charger, 2.0Ah Battery Pack (2pcs), Grinding Wheel (5pcs), Wrench, Plastic Case Packing

DCJF15(TYPE E/EK/Z)**12V+****CORDLESS SABRE SAW**

| | |
|--------------------|------------------|
| Battery | 12V/2.0Ahx2/Solo |
| Stroke Length | 14.5mm |
| Max. Cutting Depth | Metal 8mm |
| | Wood 65mm |
| | Pipe Φ 50mm |
| No-load Speed | 0-3000r/min |
| Net Weight | 1.2kg |



(Type EK) Economical model
(Type Z) Solo, Color Box Packing

Features

1. SDS quick change system, adjustable speed.

Accessories & Package

Battery Charger, 2.0Ah Battery Pack (2pcs), BIM Saw Blade, HCS Saw Blade, Plastic Case Packing

DCPM50(TYPE E/EK/Z)**12V+****CORDLESS BLIND RIVETING GUN**

| | |
|--------------|---|
| Battery | 12V/2.0Ahx2/Solo |
| Stroke | 20mm |
| Capacity | Φ 2.4- Φ 5.0 For All-purpose |
| | Φ 2.4- Φ 6.0 For Aluminum Blind Rivet |
| Max. Tension | 10000N |
| Net Weight | 1.6kg |



(Type EK) Economical model
(Type Z) Solo, Color Box Packing

Features

1. Φ 2.4- Φ 5.0 for all-purpose.

Accessories & Package

Battery Charger, 2.0Ah Battery Pack (2pcs), Nosepiece (5pcs), Mandrel Part (2pcs), Magnetic Ring, Wrench, Plastic Case Packing

DCPJ12(TYPE A/AK/Z)

12V+

CORDLESS CAULK GUN



| | |
|--------------------|------------------|
| Battery | 12V/2.0Ahx2/Solo |
| Max. Pushing Force | 3400N |
| Feed Speed | 0-12.9mm/s |
| Stroke | 213mm |
| Sealant Type | |
| Cartridge | 300ml |
| Net Weight | 1.85kg |



(Type AK) Economical model
(Type Z) Solo, Color Box Packing

Features

Adjustable speed, Cartridge 300ml.

Accessories & Package

Battery Charger, 2.0Ah Battery Pack (2pcs), Plastic Case Packing

DCPJ12(TYPE E/EK)

12V+

CORDLESS CAULK GUN



| | |
|--------------------|-------------|
| Battery | 12V/2.0Ahx2 |
| Max. Pushing Force | 3400N |
| Feed Speed | 0-12.9mm/s |
| Stroke | 213/355mm |
| Sealant Type | |
| Cartridge | 300ml |
| Film Type Pack | 600ml |
| Net Weight | 1.85kg |



(Type EK) Economical model

Features

Adjustable speed, Cartridge 300ml or film type pack 600ml.

Accessories & Package

Battery Charger, 2.0Ah Battery Pack (2pcs), 600mL Sealant Pipe Holder, Suspension Strap, Plastic Case Packing

DCPJ02-12(TYPE EM)

12V+

CORDLESS CAULK GUN



| | |
|--------------------|--------------------------------------|
| Battery | 12V/2.0Ahx2 |
| Max. Pushing Force | 8000N |
| Feed Speed | 0-4.0mm/s |
| Sealant Type | 400ml(1:1) Combination AB Sealant |
| Net Weight | 2.2kg |



(Type EM) Economical model

Features

1. Slide-in battery pack;
2. 5-Speed, Rubber-covered handle;
3. Combination AB Sealant.

Accessories & Package

Battery Charger, 2.0Ah Battery Pack (2pcs), Plastic Case Packing

DCJZ20-10(TYPE EM)

12V+

CORDLESS DRIVER DRILL



| | |
|------------------------|---------------------------------------|
| Battery | 12V/2.0Ahx2 |
| Max. Chucking Capacity | 10mm |
| No-load Speed | Low 0-400r/min High 0-1500r/min |
| Max. Drilling Capacity | Steel Φ 10mm Wood Φ 20mm |
| Torque Setting | 16+1 |
| Max. Torque | 30N·m |
| Net Weight | 1.2kg |



(Type EM) Economical model

Features

1. Slide-in battery pack;
2. 2-Speed, LED light;
3. Forward and reverse rotation.

Accessories & Package

Battery Charger, 2.0Ah Slide Battery Pack (2pcs), Driver Bit, Plastic Case Packing

DCJZ18-10 (TYPE EM)

14.4V+

CORDLESS DRIVER DRILL



| | |
|------------------------|---------------------------------------|
| Battery | 14.4V/2.0Ahx2 |
| Max. Chucking Capacity | 10mm |
| Max. Screw Dia. | 7mm |
| No-load Speed | Low 0-350r/min High 0-1300r/min |
| Max. Drilling Capacity | Steel Φ 10mm Wood Φ 20mm |
| Torque Setting | 16+1 |
| Max. Torque | 30N·m |
| Net Weight | 1.3kg |



(Type EM) Economical model

Features

1. Slide-in battery pack;
2. 2-Speed, LED light;
3. Forward and reverse rotation.

Accessories & Package

Battery Charger, 2.0Ah Slide Battery Pack (2pcs), Driver Bit, Plastic Case Packing

DCJZ16 (TYPE E/EK/Z)

18V+

CORDLESS BRUSHLESS DRILL



| | |
|------------------------|---------------------------------------|
| Battery | 18V/4.0Ahx2/Solo |
| Max. Chucking Capacity | 16mm |
| No-load Speed | 0-1200r/min |
| Max. Drilling Capacity | Steel Φ 16mm Wood Φ 38mm |
| Max. Torque | 45N·m |
| Output Spindle Threads | 1/2-20UNF |
| Net Weight | 2.2kg |



(Type EK) Economical model
(Type Z) Solo, Color Box Packing

Features

1. Brushless motor;
2. All-metal chuck;
3. Adjustable speed, LED light, Forward and reverse rotation.

Accessories & Package

Battery Charger, 4.0Ah Battery Pack (2pcs), Auxiliary Handle, Chuck Wrench, Suspension Strap, Plastic Case Packing

DCJZ13 (TYPE E/EK)**18V****CORDLESS DRIVER/HAMMER DRILL**

| | |
|------------------------|--|
| Battery | 18V/4.0Ahx2 |
| Max. Chucking Capacity | 13mm |
| Max. Screw Dia. | 10mm |
| Rated Impact Frequency | 0-36000/min |
| No-load Speed | Low 0-400r/min High 0-2000r/min |
| Max. Drilling Capacity | Steel Φ13mm Wood Φ38mm Brick Wall 14mm |
| Torque Setting | 25+2 |
| Max. Torque | 70N·m |
| Net Weight | 2.2kg |



(Type EK) Economical model

Features

1. 2-Speed, 70N.m high torque;
2. LED light, Forward and reverse rotation.

Accessories & Package

Battery Charger, 4.0Ah Battery Pack (2pcs), Auxiliary Handle, Plastic Case Packing

DCJZ13 (TYPE L/Z)**18V****CORDLESS DRIVER/HAMMER DRILL**

| | |
|------------------------|--|
| Battery | 18V/2.0Ahx2/Solo |
| Max. Chucking Capacity | 13mm |
| Max. Screw Dia. | 10mm |
| Rated Impact Frequency | 0-36000/min |
| No-load Speed | Low 0-400r/min High 0-2000r/min |
| Max. Drilling Capacity | Steel Φ13mm Wood Φ38mm Brick Wall 14mm |
| Torque Setting | 25+2 |
| Max. Torque | 70N·m |
| Net Weight | 1.9kg |



(Type Z) Solo, Color Box Packing

Features

1. 2-Speed, 70N.m high torque;
2. LED light, Forward and reverse rotation.

Accessories & Package

Battery Charger, 2.0Ah Battery Pack (2pcs), Auxiliary Handle, Plastic Case Packing

DCPL02-14(TYPE E/EK/F)**18V****CORDLESS BRUSHLESS IMPACT DRIVER**

| | |
|------------------------|---|
| Battery | 18V/4.0Ahx2/5.0Ahx2 |
| Clamping Capacity | 6.35mm Hex |
| Max. Screw Dia. | 14mm |
| Torque Setting | Smart-loosen Low 140N·m High 175N·m |
| No-load Speed | Low 0-2000r/min High 0-2400r/min |
| Rated Impact Frequency | Low 0-2900/min High 0-3200/min |
| Net Weight | 1.9kg |



(Type EK) Economical model

Features

1. Brushless motor;
2. Smart loosen function;
3. 2-Speed, LED light, Forward and reverse rotation.

Accessories & Package

Battery Charger, 4.0/5.0Ah Battery Pack (2pcs), Driver Bit, Suspension Strap, Plastic Case Packing

DCPL02-14(TYPE A/Z)**18V****CORDLESS BRUSHLESS IMPACT DRIVER**

| | |
|------------------------|---|
| Battery | 18V/2.0Ahx2/Solo |
| Clamping Capacity | 6.35mm Hex |
| Max. Screw Dia. | 14mm |
| Torque Setting | Smart-loosen Low 140N·m High 175N·m |
| No-load Speed | Low 0-2000r/min High 0-2400r/min |
| Rated Impact Frequency | Low 0-2900/min High 0-3200/min |
| Net Weight | 1.6kg |



(Type Z) Solo, Color Box Packing

Features

1. Brushless motor;
2. Smart loosen function;
3. 2-Speed, LED light, Forward and reverse rotation.

Accessories & Package

Battery Charger, 2.0Ah Battery Pack (2pcs), Driver Bit, Suspension Strap, Plastic Case Packing

DCPB02-18(TYPE E/EK/F/Z)**18V****CORDLESS BRUSHLESS IMPACT WRENCH**

| | |
|------------------------|--|
| Battery | 18V/4.0Ahx2/5.0Ahx2/Solo |
| Standard Bolt Size | M12-M18mm |
| Square Drive Size | 12.7mm(1/2") |
| Torque Setting | Smart-loosen Step L 240N·m Step H 300N·m |
| No-load Speed | Step L 0-2000r/min Step H 0-2400r/min |
| Rated Impact Frequency | Step L 0-2900/min Step H 0-3200/min |
| Net Weight | 1.8kg |

(Type EK) Economical model
(Type Z) Solo, Color Box Packing**Features**

1. Brushless motor;
2. Smart loosen function;
3. 2-Speed, LED light, Forward and reverse rotation.

Accessories & Package

Battery Charger, 4.0/5.0Ah Battery Pack (2pcs), Sockets S22, Suspension Strap, Plastic Case Packing

DCPB20(TYPE F/Z)**18V****CORDLESS IMPACT WRENCH**

| | |
|--------------------------|------------------|
| Battery | 18V/5.0Ahx2/Solo |
| Standard Bolt Size | M16-M20mm |
| Square Drive Size | 12.7mm(1/2") |
| No-load Speed | 0-1700r/min |
| Max. Impacting Frequency | 0-2000/min |
| Max. Fastening Torque | 650N·m |
| Net Weight | 3.2kg |



(Type Z) Solo, Color Box Packing

Features

1. 650N.m high torque;
2. Forward and reverse rotation, Adjustable speed;
3. LED light.

Accessories & Package

Battery Charger, 5.0Ah Battery Pack (2pcs), Plastic Case Packing

DCZC02-24(TYPE E/Z)

18V

CORDLESS BRUSHLESS ROTARY HAMMER



| | |
|------------------------|----------------------|
| Battery | 18V/4.0Ahx2/Solo |
| Max. Drilling Capacity | Concrete Φ 24mm |
| | Steel Φ 12mm |
| | Wood Φ 28mm |
| Rated Impact Frequency | 0-4900/min |
| No-load Speed | 0-1100r/min |
| Net Weight | 3.1kg |



(Type Z) Solo, Color Box Packing

Features

1. Brushless motor;
2. 3-Mode operation, drill, rotary hammer and demolition;
3. Adjustable speed, Forward and reverse rotation.

Accessories & Package

Battery Charger, 4.0Ah Battery Pack (2pcs), Auxiliary Handle, Depth Gauge, Plastic Case Packing

DCSM02-100(TYPE E/EK/F/Z)

18V

CORDLESS BRUSHLESS ANGLE GRINDER



| | |
|--------------------|--------------------------|
| Battery | 18V/4.0Ahx2/5.0Ahx2/Solo |
| Rated Speed | 8500r/min |
| Max. Wheel Dia. | Φ 100mm |
| Hole Dia. of Wheel | Φ 16mm |
| Spindle Thread | M10mm |
| Net Weight | 2.4kg |



(Type EK) Economical model
(Type Z) Solo, Color Box Packing

Features

1. Brushless motor;
2. Detachable dustproof net;
3. Anti-restart function prevent accident start;
4. Auto stop when disc lost speed.

Accessories & Package

Battery Charger, 4.0/5.0Ah Battery Pack (2pcs), Auxiliary Handle, Wrench, Plastic Case Packing

DCSM02-115(TYPE E/EK/Z)

18V

CORDLESS BRUSHLESS ANGLE GRINDER



| | |
|--------------------|------------------|
| Battery | 18V/4.0Ahx2/Solo |
| Rated Speed | 8500r/min |
| Max. Wheel Dia. | Φ 115mm |
| Hole Dia. of Wheel | Φ 22mm |
| Spindle Thread | M14mm |
| Net Weight | 2.4kg |



(Type EK) Economical model
(Type Z) Solo, Color Box Packing

Features

1. Brushless motor;
2. Detachable dustproof net;
3. Anti-restart function prevent accident start;
4. Auto stop when disc lost speed.

Accessories & Package

Battery Charger, 4.0Ah Battery Pack (2pcs), Auxiliary Handle, Wrench, Plastic Case Packing

DCSM02-125(TYPE E/EK/Z)

18V

CORDLESS BRUSHLESS ANGLE GRINDER



| | |
|--------------------|------------------|
| Battery | 18V/4.0Ahx2/Solo |
| Rated Speed | 8500r/min |
| Max. Wheel Dia. | Φ 125mm |
| Hole Dia. of Wheel | Φ 22mm |
| Spindle Thread | M14mm |
| Net Weight | 2.4kg |



(Type EK) Economical model
(Type Z) Solo, Color Box Packing

Features

1. Brushless motor;
2. Detachable dustproof net;
3. Anti-restart function prevent accident start;
4. Auto stop when disc lost speed.

Accessories & Package

Battery Charger, 4.0Ah Battery Pack (2pcs), Auxiliary Handle, Wrench, Plastic Case Packing

DCJF28(TYPE B/BK/A/Z)

18V

CORDLESS RECIPROCATING SAW



| | |
|--------------------|--------------------------|
| Battery | 18V/4.0Ahx2/5.0Ahx2/Solo |
| No-load Speed | 0-3300/min |
| Length of Strokes | 28mm |
| Max. Cutting Depth | Steel 20mm |
| | Wood 250mm |
| | Tube Φ 130mm |
| | Base Plate Adjustment 4 |
| Net Weight | 3.4kg |



(Type BK) Economical model
(Type A) 5.0Ah
(Type Z) Solo, Color Box Packing

Features

1. SDS quick change chuck;
2. Adjustable speed;
3. Large trigger switch with lock-on button.

Accessories & Package

Battery Charger, 4.0/5.0Ah Battery Pack (2pcs), BIM Saw Blade, HCS Saw Blade, Color Box Packing

DCJF28(TYPE E/EK)

18V

CORDLESS RECIPROCATING SAW



| | |
|--------------------|-------------------------|
| Battery | 18V/4.0Ahx2/5.0Ahx2 |
| No-load Speed | 0-3300/min |
| Length of Strokes | 28mm |
| Max. Cutting Depth | Steel 20mm |
| | Wood 250mm |
| | Tube Φ 130mm |
| | Base Plate Adjustment 4 |
| Net Weight | 3.4kg |



(Type EK) Economical model

Features

1. SDS quick change chuck;
2. Adjustable speed;
3. Large trigger switch with lock-on button.

Accessories & Package

Battery Charger, 4.0Ah Battery Pack (2pcs), BIM Saw Blade, HCS Saw Blade, Plastic Case Packing

DCPL6(TYPE A/Z)**18V****CORDLESS AUTO FEED SCREWDRIVER**

| | |
|-----------------------|------------------|
| Battery | 18V/2.0Ahx2/Solo |
| Drywall Screw | 3.5x25-50mm |
| Clamping Capacity | Hex Shank 6.35mm |
| Max. Screw Dia. | Φ6mm |
| Max. Fastening Torque | 12N·m |
| No-load Speed | 0-2900r/min |
| Net Weight | 2.0kg |



(Type Z) Solo, Color Box Packing

Features

1. Brushless motor, Adjustable depth of the screw;
2. Adjustable speed;
3. Suitable for various strength screws.

Accessories & Package

Battery Charger, 2.0Ah Battery Pack (2pcs), Nail Tape (2pcs), Driver Bit, Plastic Case Packing

DCQF28(TYPE B/BK/Z)**18V****CORDLESS BLOWER**

| | |
|---------------|----------------------------|
| Battery | 18V/4.0Ahx1/Solo |
| No-load Speed | |
| Low | 11000±14%r/min |
| Middle | 15000±11%r/min |
| High | 19000±10%r/min |
| Air Volumel | 1.6-2.8m ³ /min |
| Net Weight | 1.9kg |

(Type BK) Economical model
(Type Z) Solo, Color Box Packing**Features**

1. 3-Speed variable speed control;
2. Two functions: Suction and blowing.

Accessories & Package

Battery Charger, 4.0Ah Battery Pack, Dust bag, Color Box Packing

DCZC22(TYPE BM/Z)**20V****CORDLESS BRUSHLESS ROTARY HAMMER**

| | |
|------------------------|------------------|
| Battery | 20V/4.0Ahx2/Solo |
| No-load Speed | 0-1400r/min |
| Rated Impact Frequency | 0-4500/min |
| Max. Drilling Capacity | |
| Concrete | Φ22mm |
| Steel | Φ13mm |
| Wood | Φ28mm |
| Net Weight | 2.6kg |

(Type BM) Economical model
(Type Z) Solo, Color Box Packing**Features**

1. Brushless motor;
2. 3-Mode operation, drill, rotary hammer and demolition;
3. Adjustable speed, Forward and reverse rotation;
4. Electronic constant speed control, maintains constant speed under load.

Accessories & Package

Battery Charger, 4.0Ah Battery Pack (2pcs), Auxiliary Handle, Depth Gauge, Tool Carrying Bag, Color Box Packing

DCSM03-100(TYPE EM/Z)**20V****CORDLESS BRUSHLESS ANGLE GRINDER**

| | |
|--------------------|------------------|
| Battery | 20V/4.0Ahx2/Solo |
| Rated Speed | 8500r/min |
| Max. Wheel Dia. | Φ100mm |
| Hole Dia. of Wheel | Φ16mm |
| Spindle Thread | M10mm |
| Net Weight | 2.4kg |

(Type EM) Economical model
(Type Z) Solo, Color Box Packing**Features**

1. Brushless motor;
2. Detachable dustproof net;
3. Anti-restart function prevent accident start;
4. Auto stop when disc lost speed.

Accessories & Package

Battery Charger, 4.0Ah Battery Pack (2pcs), Auxiliary Handle, Wrench, Plastic Case Packing

DCSM03-115(TYPE EM/Z)**20V****CORDLESS BRUSHLESS ANGLE GRINDER**

| | |
|--------------------|------------------|
| Battery | 20V/4.0Ahx2/Solo |
| Rated Speed | 8500r/min |
| Max. Wheel Dia. | Φ115mm |
| Hole Dia. of Wheel | Φ22mm |
| Spindle Thread | M14mm |
| Net Weight | 2.4kg |

(Type EM) Economical model
(Type Z) Solo, Color Box Packing**Features**

1. Brushless motor;
2. Detachable dustproof net;
3. Anti-restart function prevent accident start;
4. Auto stop when disc lost speed.

Accessories & Package

Battery Charger, 4.0Ah Battery Pack (2pcs), Auxiliary Handle, Wrench, Plastic Case Packing

DCSM03-125(TYPE EM/Z)**20V****CORDLESS BRUSHLESS ANGLE GRINDER**

| | |
|--------------------|------------------|
| Battery | 20V/4.0Ahx2/Solo |
| Rated Speed | 8500r/min |
| Max. Wheel Dia. | Φ125mm |
| Hole Dia. of Wheel | Φ22mm |
| Spindle Thread | M14mm |
| Net Weight | 2.4kg |

(Type EM) Economical model
(Type Z) Solo, Color Box Packing**Features**

1. Brushless motor;
2. Detachable dustproof net;
3. Anti-restart function prevent accident start;
4. Auto stop when disc lost speed.

Accessories & Package

Battery Charger, 4.0Ah Battery Pack (2pcs), Auxiliary Handle, Wrench, Plastic Case Packing

DCYD30(TYPE B/BK/Z)

18V+18V

BATTERY POWERED PRUNING SHEARS

| | |
|-------------------|------------------|
| Battery | 18V/4.0Ah×2/Solo |
| Shearing Capacity | |
| Dry Branch | Φ20mm |
| Wet Branch | Φ30mm |
| Net Weight | |
| Host Machine | 1.1kg |
| Controller | 1.9kg |



(Type BK) Economical model
(Type Z) Solo, Color Box Packing

Features

1. Brushless motor;
2. Adjustable blade opening size;
3. Fast shearing speed, Large shear diameter.

Accessories & Package

Battery Charger, 4.0Ah Battery Pack (2pcs), Grease, Engine Oil, Oilstone 240#, Hex Wrench (2pcs), Wrench, Backpack, Color Box Packing



Cordless Tools



CORDLESS COMBO KIT



CORDLESS IMPACT DRIVER
DCPL02-8



CORDLESS DRIVER DRILL
DCJZ10-10

12V/2.0Ah

DCKIT01(TYPE E)



Accessories & Package

Battery Charger, 2.0Ah Battery Pack (2pcs), Plastic Case Packing

CORDLESS COMBO KIT



CORDLESS DRIVER DRILL
DCJZ10-10



CORDLESS SABRE SAW
DCJF15

12V/2.0Ah

DCKIT02(TYPE E)



Accessories & Package

Battery Charger, 2.0Ah Battery Pack (2pcs), Plastic Case Packing

Dong Cheng



DSM100B

ANGLE GRINDER

| | |
|--------------------|------------|
| Rated Power Input | 750W |
| Rated Speed | 13000r/min |
| Max. Wheel Dia. | Φ100mm |
| Hole Dia. of Wheel | Φ16mm |
| Net Weight | 1.6kg |

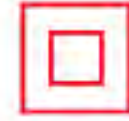

Features

Spindle lock, Top switch.

Accessories & Package

Wrench, Carbon Brush, Color Box Packing

DSM02-100A

ANGLE GRINDER

| | |
|--------------------|------------|
| Rated Power Input | 570W |
| Rated Speed | 13000r/min |
| Max. Wheel Dia. | Φ100mm |
| Hole Dia. of Wheel | Φ16mm |
| Net Weight | 1.8kg |



Features

Spindle lock, Rear toggle switch.

Accessories & Package

Wrench, Guide Assembly, Carbon Brush, Color Box Packing

DSM03-100A

ANGLE GRINDER

| | |
|--------------------|------------|
| Rated Power Input | 710W |
| Rated Speed | 13000r/min |
| Max. Wheel Dia. | Φ100mm |
| Hole Dia. of Wheel | Φ16mm |
| Net Weight | 1.6kg |

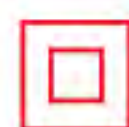

Features

Spindle lock, Slide switch.

Accessories & Package

Auxiliary Handle, Wrench, Carbon Brush, Color Box Packing

DSM04-100A

ANGLE GRINDER

| | |
|--------------------|------------|
| Rated Power Input | 560W |
| Rated Speed | 13000r/min |
| Max. Wheel Dia. | Φ100mm |
| Hole Dia. of Wheel | Φ16mm |
| Net Weight | 1.7kg |

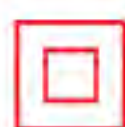

Features

Spindle lock, Rear toggle switch.

Accessories & Package

Wrench, Carbon Brush, Color Box Packing

DSM04-100B

ANGLE GRINDER

| | |
|--------------------|------------|
| Rated Power Input | 710W |
| Rated Speed | 13000r/min |
| Max. Wheel Dia. | Φ100mm |
| Hole Dia. of Wheel | Φ16mm |
| Net Weight | 1.5kg |

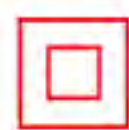

NEW

Features

1. Power improved to 710W;
2. Spindle lock, Rear toggle switch.

Accessories & Package

Wrench, Carbon Brush, Color Box Packing

DSM05-100B

ANGLE GRINDER

| | |
|--------------------|------------|
| Rated Power Input | 850W |
| Rated Speed | 13000r/min |
| Max. Wheel Dia. | Φ100mm |
| Hole Dia. of Wheel | Φ16mm |
| Net Weight | 1.7kg |



Features

Spindle lock, Slide switch.

Accessories & Package

Auxiliary Handle, Wrench, Carbon Brush, Color Box Packing

DSM06-100

ANGLE GRINDER

| | |
|--------------------|-----------|
| Rated Power Input | 800W |
| Rated Speed | 9000r/min |
| Max. Wheel Dia. | Φ100mm |
| Hole Dia. of Wheel | Φ16mm |
| Net Weight | 2.0kg |



Features

1. High overload resistance, especially suitable for cutting operation;
2. Spindle lock, Rear toggle switch.

Accessories & Package

Wrench, Carbon Brush, Color Box Packing

DSM08-100

ANGLE GRINDER

| | |
|--------------------|------------|
| Rated Power Input | 800W |
| Rated Speed | 13000r/min |
| Max. Wheel Dia. | Φ100mm |
| Hole Dia. of Wheel | Φ16mm |
| Net Weight | 1.6kg |



Features

Spindle lock, Rear toggle switch.

Accessories & Package

Wrench, Carbon Brush, Color Box Packing

DSM09-100S**ANGLE GRINDER**

| | |
|--------------------|------------|
| Rated Power Input | 800W |
| Rated Speed | 12000r/min |
| Max. Wheel Dia. | Φ100mm |
| Hole Dia. of Wheel | Φ16mm |
| Net Weight | 1.6kg |

**Features**

1. Slim handle;
2. Detachable dustproof net, Auto stop carbon brush;
3. Spindle lock, Slide switch.

Accessories & Package

Wrench, Carbon Brush, Color Box Packing

DSM10-100**ANGLE GRINDER**

| | |
|--------------------|-----------------|
| Rated Power Input | 1020W |
| Rated Speed | 4200-13000r/min |
| Max. Wheel Dia. | Φ100mm |
| Hole Dia. of Wheel | Φ16mm |
| Net Weight | 2.1kg |

**Features**

1. 1020W high power, Adjustable speed;
2. Constant output power, maintains constant power under load;
3. Spindle lock, Slide switch.

Accessories & Package

Auxiliary Handle, Wrench, Carbon Brush, Color Box Packing

DSM10-100S**ANGLE GRINDER**

| | |
|--------------------|------------|
| Rated Power Input | 1020W |
| Rated Speed | 13000r/min |
| Max. Wheel Dia. | Φ100mm |
| Hole Dia. of Wheel | Φ16mm |
| Net Weight | 2.1kg |

**Features**

1. 1020W high power;
2. Spindle lock, Slide switch.

Accessories & Package

Auxiliary Handle, Wrench, Carbon Brush, Color Box Packing

DSM10-100H**ANGLE GRINDER**

| | |
|--------------------|------------|
| Rated Power Input | 1020W |
| Rated Speed | 13000r/min |
| Max. Wheel Dia. | Φ100mm |
| Hole Dia. of Wheel | Φ16mm |
| Net Weight | 2.1kg |

**Features**

1. 1020W high power;
2. Long handle design, more suitable for grinding work;
3. Spindle lock, Large trigger switch.

Accessories & Package

Auxiliary Handle, Wrench, Carbon Brush, Color Box Packing

DSM12-100**ANGLE GRINDER**

| | |
|--------------------|------------|
| Rated Power Input | 850W |
| Rated Speed | 13000r/min |
| Max. Wheel Dia. | Φ100mm |
| Hole Dia. of Wheel | Φ16mm |
| Net Weight | 1.8kg |

**Features**

1. Labyrinth dustproof structure;
2. Auto stop carbon brush;
3. High strength gears for longer lifetime;
4. Spindle lock, Slide switch.

Accessories & Package

Auxiliary Handle, Wrench, Carbon Brush, Color Box Packing

DSM12-100B**ANGLE GRINDER**

| | |
|--------------------|------------|
| Rated Power Input | 850W |
| Rated Speed | 13000r/min |
| Max. Wheel Dia. | Φ100mm |
| Hole Dia. of Wheel | Φ16mm |
| Net Weight | 1.6kg |

**Features**

1. Labyrinth dustproof structure;
2. Auto stop carbon brush;
3. High strength gears for longer lifetime;
4. Spindle lock, Rear toggle switch.

Accessories & Package

Wrench, Carbon Brush, Color Box Packing

DSM13-100**ANGLE GRINDER**

| | |
|--------------------|------------|
| Rated Power Input | 820W |
| Rated Speed | 13000r/min |
| Max. Wheel Dia. | Φ100mm |
| Hole Dia. of Wheel | Φ16mm |
| Net Weight | 1.5kg |

**Features**

1. Slim handle;
2. Labyrinth dustproof structure;
3. Auto stop carbon brush;
4. Spindle lock, Rear toggle switch.

Accessories & Package

Wrench, Carbon Brush, Color Box Packing

DSM14-100**ANGLE GRINDER**

| | |
|--------------------|------------|
| Rated Power Input | 800W |
| Rated Speed | 13000r/min |
| Max. Wheel Dia. | Φ100mm |
| Hole Dia. of Wheel | Φ16mm |
| Net Weight | 1.5kg |

**Features**

1. Slim handle;
2. Labyrinth dustproof structure;
3. Auto stop carbon brush;
4. Spindle lock, Large paddle switch.

Accessories & Package

Auxiliary Handle, Wrench, Carbon Brush, Color Box Packing

DSM15-100B

ANGLE GRINDER

| | |
|--------------------|------------|
| Rated Power Input | 720W |
| Rated Speed | 13000r/min |
| Max. Wheel Dia. | Φ100mm |
| Hole Dia. of Wheel | Φ16mm |
| Net Weight | 1.5kg |



Features

1. Labyrinth dustproof structure;
2. Auto stop carbon brush;
3. Spindle lock, Rear toggle switch.

Accessories & Package

Auxiliary Handle, Wrench, Carbon Brush, Color Box Packing

DSM115B

ANGLE GRINDER

| | |
|--------------------|------------|
| Rated Power Input | 750W |
| Rated Speed | 11800r/min |
| Max. Wheel Dia. | Φ115mm |
| Hole Dia. of Wheel | Φ22mm |
| Net Weight | 1.6kg |



Features

Spindle lock, Top switch.

Accessories & Package

Wrench, Carbon Brush, Color Box Packing

DSM02-115

ANGLE GRINDER

| | |
|--------------------|------------|
| Rated Power Input | 710W |
| Rated Speed | 11800r/min |
| Max. Wheel Dia. | Φ115mm |
| Hole Dia. of Wheel | Φ22mm |
| Net Weight | 1.6kg |



Features

Spindle lock, Slide switch.

Accessories & Package

Auxiliary Handle, Wrench, Carbon Brush, Color Box Packing

DSM03-115

ANGLE GRINDER

| | |
|--------------------|------------|
| Rated Power Input | 850W |
| Rated Speed | 11800r/min |
| Max. Wheel Dia. | Φ115mm |
| Hole Dia. of Wheel | Φ22mm |
| Net Weight | 1.8kg |



Features

Spindle lock, Slide switch.

Accessories & Package

Auxiliary Handle, Wrench, Carbon Brush, Color Box Packing

DSM06-115

ANGLE GRINDER

| | |
|--------------------|------------|
| Rated Power Input | 1200W |
| Rated Speed | 11800r/min |
| Max. Wheel Dia. | Φ115mm |
| Hole Dia. of Wheel | Φ22mm |
| Net Weight | 3.0kg |



Features

1. 1200W high power;
2. Spindle lock, Large trigger switch.

Accessories & Package

Auxiliary Handle, Wrench, Carbon Brush, Color Box Packing

DSM07-115

ANGLE GRINDER

| | |
|--------------------|-----------------------|
| Rated Power Input | 1020W |
| Rated Speed | 11800/4200-11800r/min |
| Max. Wheel Dia. | Φ115mm |
| Hole Dia. of Wheel | Φ22mm |
| Net Weight | 2.1kg |



Features

1. 1020W high power;
2. Optional function: Adjustable speed;
3. Spindle lock, Slide switch.

Accessories & Package

Auxiliary Handle, Wrench, Carbon Brush, Color Box Packing

DSM07-115H

ANGLE GRINDER

| | |
|--------------------|------------|
| Rated Power Input | 1020W |
| Rated Speed | 11800r/min |
| Max. Wheel Dia. | Φ115mm |
| Hole Dia. of Wheel | Φ22mm |
| Net Weight | 2.1kg |



Features

1. 1020W high power;
2. Long handle design, more suitable for grinding work;
3. Spindle lock, Large trigger switch.

Accessories & Package

Auxiliary Handle, Wrench, Carbon Brush, Color Box Packing

DSM09-115S

ANGLE GRINDER

| | |
|--------------------|------------|
| Rated Power Input | 800W |
| Rated Speed | 11800r/min |
| Max. Wheel Dia. | Φ115mm |
| Hole Dia. of Wheel | Φ22mm |
| Net Weight | 1.6kg |



Features

1. Slim handle;
2. Detachable dustproof net, Auto stop carbon brush;
3. Spindle lock, Slide switch.

Accessories & Package

Wrench, Carbon Brush, Color Box Packing

DSM12-115**ANGLE GRINDER**

| | |
|--------------------|------------|
| Rated Power Input | 850W |
| Rated Speed | 11800r/min |
| Max. Wheel Dia. | Φ115mm |
| Hole Dia. of Wheel | Φ22mm |
| Net Weight | 1.8kg |

**Features**

1. Labyrinth dustproof structure;
2. Auto stop carbon brush;
3. High strength gears for longer lifetime;
4. Spindle lock, Slide switch.

Accessories & Package

Auxiliary Handle, Wrench, Carbon Brush, Color Box Packing

DSM14-115**ANGLE GRINDER**

| | |
|--------------------|------------|
| Rated Power Input | 800W |
| Rated Speed | 11800r/min |
| Max. Wheel Dia. | Φ115mm |
| Hole Dia. of Wheel | Φ22mm |
| Net Weight | 1.5kg |

**Features**

1. Slim handle;
2. Labyrinth dustproof structure;
3. Auto stop carbon brush;
4. Spindle lock, Large paddle switch.

Accessories & Package

Auxiliary Handle, Wrench, Carbon Brush, Color Box Packing

DSM125A**ANGLE GRINDER**

| | |
|--------------------|------------|
| Rated Power Input | 850W |
| Rated Speed | 11800r/min |
| Max. Wheel Dia. | Φ125mm |
| Hole Dia. of Wheel | Φ22mm |
| Net Weight | 1.8kg |

**Features**

- Spindle lock, Slide switch.

Accessories & Package

Auxiliary Handle, Wrench, Carbon Brush, Color Box Packing

DSM02-125B**ANGLE GRINDER**

| | |
|--------------------|------------|
| Rated Power Input | 1200W |
| Rated Speed | 11800r/min |
| Max. Wheel Dia. | Φ125mm |
| Hole Dia. of Wheel | Φ22mm |
| Net Weight | 3.0kg |

**Features**

1. 1200W high power;
2. Spindle lock, Large trigger switch.

Accessories & Package

Auxiliary Handle, Wrench, Carbon Brush, Color Box Packing

DSM03-125**ANGLE GRINDER**

| | |
|--------------------|-----------|
| Rated Power Input | 800W |
| Rated Speed | 9000r/min |
| Max. Wheel Dia. | Φ125mm |
| Hole Dia. of Wheel | Φ22mm |
| Net Weight | 2.1kg |

**Features**

1. High overload resistance, especially suitable for cutting operation;
2. Spindle lock, Rear toggle switch.

Accessories & Package

Auxiliary Handle, Wrench, Carbon Brush, Color Box Packing

DSM04-125**ANGLE GRINDER**

| | |
|--------------------|-----------------|
| Rated Power Input | 1020W |
| Rated Speed | 4200-11800r/min |
| Max. Wheel Dia. | Φ125mm |
| Hole Dia. of Wheel | Φ22mm |
| Net Weight | 2.1kg |

**Features**

1. 1020W high power, Adjustable speed;
2. Constant output power, maintains constant power under load;
3. Spindle lock, Slide switch.

Accessories & Package

Auxiliary Handle, Wrench, Carbon Brush, Color Box Packing

DSM04-125S**ANGLE GRINDER**

| | |
|--------------------|------------|
| Rated Power Input | 1020W |
| Rated Speed | 11800r/min |
| Max. Wheel Dia. | Φ125mm |
| Hole Dia. of Wheel | Φ22mm |
| Net Weight | 2.1kg |

**Features**

1. 1020W high power;
2. Spindle lock, Slide switch.

Accessories & Package

Auxiliary Handle, Wrench, Carbon Brush, Color Box Packing

DSM06-125**ANGLE GRINDER**

| | |
|--------------------|------------|
| Rated Power Input | 850W |
| Rated Speed | 11800r/min |
| Max. Wheel Dia. | Φ125mm |
| Hole Dia. of Wheel | Φ22mm |
| Net Weight | 1.8kg |

**Features**

1. Labyrinth dustproof structure;
2. Auto stop carbon brush;
3. High strength gears for longer lifetime;
4. Spindle lock, Slide switch.

Accessories & Package

Auxiliary Handle, Wrench, Carbon Brush, Color Box Packing

DSM07-125

ANGLE GRINDER

| | |
|--------------------|------------|
| Rated Power Input | 1500W |
| Rated Speed | 11800r/min |
| Max. Wheel Dia. | Φ125mm |
| Hole Dia. of Wheel | Φ22mm |
| Net Weight | 2.9kg |



Features

1. 1500W high power;
2. Auto stop carbon brush;
3. Spindle lock, Large trigger switch.

Accessories & Package

Auxiliary Handle, Wrench, Carbon Brush, Color Box Packing



DSM08-125H

ANGLE GRINDER

| | |
|--------------------|------------|
| Rated Power Input | 1020W |
| Rated Speed | 11800r/min |
| Max. Wheel Dia. | Φ125mm |
| Hole Dia. of Wheel | Φ22mm |
| Net Weight | 2.1kg |



Features

1. 1020W high power;
2. Long handle design, more suitable for grinding work;
3. Spindle lock, Large trigger switch.

Accessories & Package

Auxiliary Handle, Wrench, Carbon Brush, Color Box Packing

DSM09-125S

ANGLE GRINDER

| | |
|--------------------|------------|
| Rated Power Input | 800W |
| Rated Speed | 11800r/min |
| Max. Wheel Dia. | Φ125mm |
| Hole Dia. of Wheel | Φ22mm |
| Net Weight | 1.6kg |



Features

1. Slim handle;
2. Detachable dustproof net, Auto stop carbon brush;
3. Spindle lock, Slide switch.

Accessories & Package

Auxiliary Handle, Wrench, Carbon Brush, Color Box Packing

DSM150A

ANGLE GRINDER

| | |
|--------------------|-----------|
| Rated Power Input | 1200W |
| Rated Speed | 9000r/min |
| Max. Wheel Dia. | Φ150mm |
| Hole Dia. of Wheel | Φ22mm |
| Net Weight | 3.0kg |



Features

Spindle lock, Large trigger switch.

Accessories & Package

Auxiliary Handle, Wrench, Carbon Brush, Color Box Packing

DSM03-150

ANGLE GRINDER

| | |
|--------------------|----------------|
| Rated Power Input | 1400W |
| Rated Speed | 1500-9000r/min |
| Max. Wheel Dia. | Φ150mm |
| Hole Dia. of Wheel | Φ22mm |
| Net Weight | 3.3kg |



Features

1. Adjustable speed;
2. Spindle lock, Large trigger switch.

Accessories & Package

Auxiliary Handle, Wrench, Carbon Brush, Color Box Packing

DSM03-150S

ANGLE GRINDER

| | |
|--------------------|-----------|
| Rated Power Input | 1400W |
| Rated Speed | 9000r/min |
| Max. Wheel Dia. | Φ150mm |
| Hole Dia. of Wheel | Φ22mm |
| Net Weight | 3.3kg |



Features

Spindle lock, Large trigger switch.

Accessories & Package

Auxiliary Handle, Wrench, Carbon Brush, Color Box Packing

DSM04-150

ANGLE GRINDER

| | |
|--------------------|------------|
| Rated Power Input | 1500W |
| Rated Speed | 10000r/min |
| Max. Wheel Dia. | Φ150mm |
| Hole Dia. of Wheel | Φ22mm |
| Net Weight | 2.9kg |



Features

1. 1500W high power;
2. Auto stop carbon brush;
3. Spindle lock, Large trigger switch.

Accessories & Package

Auxiliary Handle, Wrench, Carbon Brush, Color Box Packing

DSM180A**ANGLE GRINDER**

| | |
|--------------------|-----------|
| Rated Power Input | 2200W |
| Rated Speed | 8300r/min |
| Max. Wheel Dia. | Φ180mm |
| Hole Dia. of Wheel | Φ22mm |
| Net Weight | 5.0kg |



Optional Function:Soft Start

Features

Spindle lock, Large trigger switch.

Accessories & Package

Auxiliary Handle, Wrench, Carbon Brush, Color Box Packing

DSM180SH**ANGLE GRINDER**

| | |
|--------------------|-----------|
| Rated Power Input | 2600W |
| Rated Speed | 8400r/min |
| Max. Wheel Dia. | Φ180mm |
| Hole Dia. of Wheel | Φ22mm |
| Net Weight | 5.8kg |



Optional Function:Soft Start

Features

1. Heavy-duty grade, especially suitable for stone material market;
2. Auto stop carbon brush;
3. Built-in belleville spring carbon brush holder structure;
4. Spindle lock, Large trigger switch.

Accessories & Package

Auxiliary Handle, Wrench, Carbon Brush, Color Box Packing

DSM02-180B**ANGLE GRINDER**

| | |
|--------------------|-----------|
| Rated Power Input | 2200W |
| Rated Speed | 8300r/min |
| Max. Wheel Dia. | Φ180mm |
| Hole Dia. of Wheel | Φ22mm |
| Net Weight | 5.0kg |



Optional Function:Soft Start

Features

Spindle lock, Large trigger switch.

Accessories & Package

Auxiliary Handle, Wrench, Carbon Brush, Color Box Packing

DSM03-180**ANGLE GRINDER**

| | |
|--------------------|-----------|
| Rated Power Input | 2200W |
| Rated Speed | 8300r/min |
| Max. Wheel Dia. | Φ180mm |
| Hole Dia. of Wheel | Φ22mm |
| Net Weight | 5.0kg |



Optional Function:Soft Start

Features

Spindle lock, Large trigger switch.

Accessories & Package

Auxiliary Handle, Wrench, Carbon Brush, Color Box Packing

DSM05-180**ANGLE GRINDER**

| | |
|--------------------|-----------|
| Rated Power Input | 2800W |
| Rated Speed | 8300r/min |
| Max. Wheel Dia. | Φ180mm |
| Hole Dia. of Wheel | Φ22mm |
| Net Weight | 5.0kg |



Optional Function:Soft Start

Features

1. Heavy-duty grade;
2. Auto stop carbon brush;
3. Built-in belleville spring carbon brush holder structure;
4. Spindle lock, Large trigger switch.

Accessories & Package

Auxiliary Handle, Wrench, Carbon Brush, Color Box Packing

DSM230A**ANGLE GRINDER**

| | |
|--------------------|-----------|
| Rated Power Input | 2200W |
| Rated Speed | 6600r/min |
| Max. Wheel Dia. | Φ230mm |
| Hole Dia. of Wheel | Φ22mm |
| Net Weight | 5.0kg |



Optional Function:Soft Start

Features

Spindle lock, Large trigger switch.

Accessories & Package

Auxiliary Handle, Wrench, Carbon Brush, Color Box Packing

DSM230SH**ANGLE GRINDER**

| | |
|--------------------|-----------|
| Rated Power Input | 2600W |
| Rated Speed | 6600r/min |
| Max. Wheel Dia. | Φ230mm |
| Hole Dia. of Wheel | Φ22mm |
| Net Weight | 5.8kg |



Optional Function:Soft Start

Features

1. Heavy-duty grade, especially suitable for stone material market
2. Auto stop carbon brush;
3. Built-in belleville spring carbon brush holder structure;
4. Spindle lock, Large trigger switch.

Accessories & Package

Auxiliary Handle, Wrench, Carbon Brush, Color Box Packing

DSM02-230B**ANGLE GRINDER**

| | |
|--------------------|-----------|
| Rated Power Input | 2200W |
| Rated Speed | 6600r/min |
| Max. Wheel Dia. | Φ230mm |
| Hole Dia. of Wheel | Φ22mm |
| Net Weight | 5.5kg |



Optional Function:Soft Start

Features

Spindle lock, Large trigger switch.

Accessories & Package

Auxiliary Handle, Wrench, Carbon Brush, Color Box Packing

DSM03-230

ANGLE GRINDER



| | |
|--------------------|-----------|
| Rated Power Input | 2200W |
| Rated Speed | 6600r/min |
| Max. Wheel Dia. | Φ230mm |
| Hole Dia. of Wheel | Φ22mm |
| Net Weight | 5.0kg |



Optional Function: Soft Start

Features

Spindle lock, Large trigger switch.

Accessories & Package

Auxiliary Handle, Wrench, Carbon Brush, Color Box Packing

DSM05-230

ANGLE GRINDER



| | |
|--------------------|-----------|
| Rated Power Input | 2800W |
| Rated Speed | 6600r/min |
| Max. Wheel Dia. | Φ230mm |
| Hole Dia. of Wheel | Φ22mm |
| Net Weight | 5.0kg |



Optional Function: Soft Start

Features

1. Heavy-duty grade;
2. Auto stop carbon brush;
3. Built-in belleville spring carbon brush holder structure;
4. Spindle lock, Large trigger switch.

Accessories & Package

Auxiliary Handle, Wrench, Carbon Brush, Color Box Packing

DSP180

POLISHER



| | |
|-------------------|----------------|
| Rated Power Input | 750W |
| No-load Speed | 1900-3200r/min |
| Wheel Size | Φ180mm |
| Net Weight | 3.6kg |



Features

Adjustable speed.

Accessories & Package

Wool Bonnet, Wrench, Auxiliary Handle, Carbon Brush, Color Box Packing

DSP02-180

POLISHER



| | |
|-------------------|----------------|
| Rated Power Input | 570W |
| No-load Speed | 1000-2400r/min |
| Wheel Size | Φ180mm |
| Net Weight | 3.3kg |



Features

Adjustable speed, Vertical structure.

Accessories & Package

Wool Bonnet, Wrench, Auxiliary Handle, Carbon Brush, Color Box Packing

DSP03-180

POLISHER



| | |
|-------------------|----------------|
| Rated Power Input | 1020W |
| No-load Speed | 1000-3600r/min |
| Wheel Size | Φ180mm |
| Net Weight | 3.6kg |



Features

Adjustable speed, D-shape auxiliary handle.

Accessories & Package

Wool Bonnet, Wrench, Hex Wrench, Carbon Brush, Color Box Packing

DSP04-180

POLISHER



| | |
|-------------------|---------------|
| Rated Power Input | 1400W |
| No-load Speed | 690-3800r/min |
| Wheel Size | Φ180mm |
| Net Weight | 3.4kg |



Features

1. 1400W High Power;
2. Electronic constant speed control, maintains constant speed under load;
2. Adjustable speed, D-shape auxiliary handle.

Accessories & Package

Wool Bonnet, Hex Wrench, Carbon Brush, Color Box Packing

DSP04-180B

POLISHER



| | |
|-------------------|---------------|
| Rated Power Input | 1150W |
| No-load Speed | 600-3400r/min |
| Wheel Size | Φ180mm |
| Net Weight | 3.4kg |



Features

1. Economical model;
2. Adjustable speed, D-shape auxiliary handle.

Accessories & Package

Wool Bonnet, Hex Wrench, Carbon Brush, Color Box Packing



DSP05-180**POLISHER**

| | |
|-------------------|-------------------|
| Rated Power Input | 1250W |
| No-load Speed | 0-600/0-3500r/min |
| Wheel Size | Φ180mm |
| Net Weight | 3.4kg |

**Features**

1. Electronic constant speed, Rubber covered gear box;
2. 8 gear adjustable speed, power-off protection;
3. Dustproof net design;
4. Overload protection.

Accessories & Package

Polished sponge tray, Auxiliary Handle, D-shape Auxiliary Handle, Hex Wrench, Socket Head Cap Screw, Carbon Brush, Color Box Packing

DSJ03-10**DIE GRINDER**

| | |
|--------------------------|------------------|
| Rated Power Input | 105W |
| No-load Speed | 14000-30000r/min |
| Max. Grinding Wheel Dia. | Φ10mm |
| Max. Collet Size | 3mm |
| Net Weight | 0.6kg |

**Features**

1. Adjustable speed;
2. Small and compact, Half structure.

Accessories & Package

Wrench, Carbon Brush, Color Box Packing

DSJ02-10**DIE GRINDER**

| | |
|--------------------------|------------|
| Rated Power Input | 105W |
| No-load Speed | 30000r/min |
| Max. Grinding Wheel Dia. | Φ10mm |
| Max. Collet Size | 3mm |
| Net Weight | 0.8kg |

**Features**

Small and compact, Half structure.

Accessories & Package

Wrench, Carbon Brush, Color Box Packing

DSJ25**DIE GRINDER**

| | |
|--------------------------|------------|
| Rated Power Input | 240W |
| No-load Speed | 26000r/min |
| Max. Grinding Wheel Dia. | Φ25mm |
| Max. Collet Size | 6mm |
| Net Weight | 1.2kg |

**Features**

Half structure.

Accessories & Package

Large Wrench, Small Wrench, Carbon Brush, Color Box Packing

DSJ25B**DIE GRINDER**

| | |
|--------------------------|------------|
| Rated Power Input | 240W |
| No-load Speed | 26000r/min |
| Max. Grinding Wheel Dia. | Φ25mm |
| Max. Collet Size | 6mm |
| Net Weight | 1.2kg |

**Features**

Half structure.

Accessories & Package

Large Wrench, Small Wrench, Carbon Brush, Color Box Packing

DSJ02-25**DIE GRINDER**

| | |
|--------------------------|------------|
| Rated Power Input | 400W |
| No-load Speed | 27000r/min |
| Max. Grinding Wheel Dia. | Φ25mm |
| Max. Collet Size | 6mm |
| Net Weight | 1.8kg |

**Features**

Metal gear box.

Accessories & Package

Large Wrench, Small Wrench, Collet, Barrel Guard, Carbon Brush, Color Box Packing

DSJ03-25**DIE GRINDER**

| | |
|--------------------------|------------|
| Rated Power Input | 400W |
| No-load Speed | 27000r/min |
| Max. Grinding Wheel Dia. | Φ25mm |
| Max. Collet Size | 6mm |
| Net Weight | 1.8kg |

**Features**

Slim front, Metal gear box.

Accessories & Package

Wrench, Collet, Carbon Brush, Color Box Packing

DSJ04-25**DIE GRINDER**

| | |
|--------------------------|------------|
| Rated Power Input | 260W |
| No-load Speed | 26700r/min |
| Max. Grinding Wheel Dia. | Φ25mm |
| Max. Collet Size | 6mm |
| Net Weight | 1.3kg |

**Features**

1. Chuck type, Metal gear box;
2. Slide switch.

Accessories & Package

Chuck Wrench, Carbon Brush, Color Box Packing

DSJ04-25E

DIE GRINDER

| | |
|--------------------------|------------------|
| Rated Power Input | 260W |
| No-load Speed | 13000-26700r/min |
| Max. Grinding Wheel Dia. | Φ25mm |
| Max. Collet Size | 6mm |
| Net Weight | 1.1kg |



Features

1. Chuck type, Metal gear box;
2. Adjustable speed, Rear toggle switch.

Accessories & Package

Chuck Wrench, Carbon Brush, Color Box Packing

DSJ05-25

DIE GRINDER

| | |
|--------------------------|-----------------|
| Rated Power Input | 550W |
| No-load Speed | 9000-26700r/min |
| Max. Grinding Wheel Dia. | Φ25mm |
| Max. Collet Size | 6mm |
| Net Weight | 1.6kg |



Features

1. Adjustable speed;
2. Slim front, Metal gear box;
3. Constant output power, maintains constant power under load.

Accessories & Package

Wrench, Collet, Barrel Guard, Carbon Brush, Color Box Packing

DSJ06-25

DIE GRINDER

| | |
|--------------------------|----------------|
| Rated Power Input | 750W |
| No-load Speed | 3800-8300r/min |
| Max. Grinding Wheel Dia. | Φ25mm |
| Max. Collet Size | 6mm |
| Net Weight | 1.6kg |



Features

1. 750W High Power;
2. Adjustable speed, Metal gear box;
3. Constant output power, maintains constant power under load.

Accessories & Package

Special Wrench, Wrench, Collet, Carbon Brush, Color Box Packing

DSJ07-25

DIE GRINDER

| | |
|--------------------------|------------|
| Rated Power Input | 240W |
| No-load Speed | 26700r/min |
| Max. Grinding Wheel Dia. | Φ25mm |
| Max. Collet Size | 6mm |
| Net Weight | 1.3kg |



Features

1. Ultra-short body;
2. Rubberized slim front.

Accessories & Package

Special Wrench, Large Wrench, Collet, Carbon Brush, Color Box Packing

DSN100

GRINDING POLISHER

| | |
|-------------------|---------------|
| Rated Power Input | 1400W |
| No-load Speed | 690-3800r/min |
| Wheel Size | Φ120×100mm |
| Net Weight | 4.7kg |



Features

1. Adjustable speed;
2. Electronic constant speed control, maintains constant speed under load.

Accessories & Package

Auxiliary Handle, Wrench, Carbon Brush, Color Box Packing

DSS125B

STRAIGHT GRINDER

| | |
|------------------------|-----------|
| Rated Power Input | 710W |
| No-load Speed | 5300r/min |
| Max. Wheel Diameter | Φ125mm |
| Hole Diameter of Wheel | Φ20mm |
| Net Weight | 4.3kg |



Features

1. Safety guard design;
2. Steady operation.

Accessories & Package

Wrench, Sleeve, Carbon Brush, Color Box Packing

DSS150

STRAIGHT GRINDER

| | |
|------------------------|-----------|
| Rated Power Input | 1020W |
| No-load Speed | 5000r/min |
| Max. Wheel Diameter | Φ150mm |
| Hole Diameter of Wheel | Φ20mm |
| Net Weight | 4.7kg |



Features

1. Safety guard design;
2. Steady operation.

Accessories & Package

Wrench, Sleeve, Carbon Brush, Color Box Packing

DSE125

BENCH GRINDER

| | |
|-------------------|-----------------|
| Rated Power Input | 250W |
| No-load Speed | 2840r/min |
| Wheel Dia. | Φ125x16xΦ12.7mm |
| Net Weight | 6.8kg |



Features

Double grinding wheel: coarse and fine grinding wheel.

Accessories & Package

Eyeshield Assembly (2pcs), Color Box Packing

DSE150**BENCH GRINDER**

| | |
|-------------------|---------------|
| Rated Power Input | 250W |
| No-load Speed | 2840r/min |
| Wheel Dia. | Φ150x20xΦ32mm |
| Net Weight | 7.6kg |

**Features**

Double grinding wheel: coarse and fine grinding wheel.

Accessories & Package

Eyeshield Assembly (2pcs), Shappinging Holder (2pcs), Color Box Packing

DSE200**BENCH GRINDER**

| | |
|---------------|---------------|
| Rated Power | 370W |
| No-load Speed | 2840r/min |
| Wheel Dia. | Φ200x20xΦ32mm |
| Net Weight | 12.9kg |

**Features**

Double grinding wheel: coarse and fine grinding wheel.

Accessories & Package

Eyeshield Assembly (2pcs), Shappinging Holder (2pcs), Color Box Packing

D3SE250**BENCH GRINDER**

| | |
|---------------|---------------|
| Rated Power | 500W |
| No-load Speed | 2840r/min |
| Wheel Dia. | Φ250x25xΦ32mm |
| Net Weight | 21.5kg |



⚡ 380V

Features

1. Three-phase motor;
2. Double grinding wheel: coarse and fine grinding wheel.

Accessories & Package

Eyeshield Assembly (2pcs), Shappinging Holder (2pcs), Color Box Packing

D3SE250L**PEDESTAL GRINDER**

| | |
|-------------------|---------------|
| Rated Power Input | 750W |
| No-load Speed | 2840r/min |
| Max. Wheel Dia. | Φ250x25xΦ32mm |
| Net Weight | 50kg |



⚡ 380V

Features

1. Three-phase motor, Floor-standing;
2. Double grinding wheel: coarse and fine grinding wheel.

Accessories & Package

Eyeshield Assembly (2pcs), Shappinging Holder (2pcs), Color Box Packing

DSA125**RANDOM ORBIT SANDER**

| | |
|-------------------|-----------------|
| Rated Power Input | 300W |
| Orbits Frequency | 4000-12000r/min |
| Pad Size | Φ125mm |
| Net Weight | 1.4kg |

**Features**

1. Ultra low vibration structure design;
2. Adjustable speed, Dust bag design.

Accessories & Package

Dust Bag, Carbon Brush, Color Box Packing

DSA150**DISK SANDER**

| | |
|--------------------|-----------|
| Rated Power Input | 405W |
| Orbits Frequency | 4700r/min |
| Grinding Disc Dia. | Φ150mm |
| Net Weight | 1.6kg |

**Features**

Vertical type.

Accessories & Package

Auxiliary Handle, Hex Wrench, Abrasive Disc P24, Abrasive Disc P120, Carbon Brush, Color Box Packing

DSB104**ORBITAL SANDER**

| | |
|-------------------|-----------|
| Rated Power Input | 200W |
| Orbits Frequency | 13000/min |
| Pad Size | 70x104mm |
| Net Weight | 1.2kg |

**Features**

1. Small and lightweight body;
2. Rubber-covered body.

Accessories & Package

Carbon Brush, Color Box Packing



DSB100

ORBITAL SANDER

| | |
|-------------------|-----------|
| Rated Power Input | 150W |
| Orbits Frequency | 12000/min |
| Pad Size | 100×110mm |
| Net Weight | 1.3kg |



Features

Economical model.

Accessories & Package

Carbon Brush, Color Box Packing

DSB100B

ORBITAL SANDER

| | |
|-------------------|-----------|
| Rated Power Input | 180W |
| Orbits Frequency | 13000/min |
| Pad Size | 100×110mm |
| Net Weight | 1.3kg |



Features

Power improved to 180W.

Accessories & Package

Carbon Brush, Color Box Packing

DSB02-100

ORBITAL SANDER

| | |
|-------------------|-----------|
| Rated Power Input | 200W |
| Orbits Frequency | 14000/min |
| Pad Size | 100x110mm |
| Net Weight | 1.3kg |



Features

Rubber-covered body, Dust bag design.

Accessories & Package

Dust Bag, Carbon Brush, Color Box Packing

DSB03-100

ORBITAL SANDER

| | |
|-------------------|-----------|
| Rated Power Input | 240W |
| Orbits Frequency | 14000/min |
| Pad Size | 100x110mm |
| Net Weight | 1.2kg |



Features

Rubber-covered body, Comfortable to grip.

Accessories & Package

Carbon Brush, Color Box Packing

DSB04-100

ORBITAL SANDER

| | |
|-------------------|-----------|
| Rated Power Input | 240W |
| Orbits Frequency | 14000/min |
| Pad Size | 100x110mm |
| Net Weight | 1.2kg |



Features

Whole rubber-covered body, more Comfortable to grip.

Accessories & Package

Carbon Brush, Color Box Packing

DSB185

ORBITAL SANDER

| | |
|-------------------|-----------|
| Rated Power Input | 180W |
| Orbits Frequency | 10000/min |
| Pad Size | 93×185mm |
| Net Weight | 1.7kg |



Features

Trigger switch with lock-on button.

Accessories & Package

Carbon Brush, Color Box Packing

DSB185B

ORBITAL SANDER

| | |
|-------------------|-----------|
| Rated Power Input | 200W |
| Orbits Frequency | 11000/min |
| Pad Size | 93×185mm |
| Net Weight | 1.6kg |



Features

1. Power improved to 200W;
2. Trigger switch with lock-on button.

Accessories & Package

Carbon Brush, Color Box Packing

DSB02-185

ORBITAL SANDER

| | |
|-------------------|-----------|
| Rated Power Input | 220W |
| Orbits Frequency | 12000/min |
| Pad Size | 93x185mm |
| Net Weight | 1.6kg |



Features

1. Rubber-covered body;
2. Trigger switch with lock-on button.

Accessories & Package

Carbon Brush, Color Box Packing

DSB234**ORBITAL SANDER**

| | |
|-------------------|-----------|
| Rated Power Input | 520W |
| Orbits Frequency | 10000/min |
| Pad Size | 114x234mm |
| Net Weight | 2.9kg |

**Features**

Trigger switch with lock-on button.

Accessories & Package

Carbon Brush, Color Box Packing

DSB02-234**ORBITAL SANDER**

| | |
|-------------------|-----------|
| Rated Power Input | 330W |
| Orbits Frequency | 10000/min |
| Pad Size | 114x227mm |
| Net Weight | 2.9kg |

**Features**

Rubber-covered body, Self- dust collection.

Accessories & Package

Perforated Plate, Carbon Brush, Color Box Packing

DSB02-234B**ORBITAL SANDER**

| | |
|-------------------|-----------|
| Rated Power Input | 330W |
| Orbits Frequency | 7500/min |
| Pad Size | 114x227mm |
| Net Weight | 2.9kg |

**Features**

1. Electronic constant speed control, maintains constant speed under load;
2. Rubber-covered body, Self- Dust collection.

Accessories & Package

Perforated Plate, Carbon Brush, Color Box Packing

DST9x533**BELT SANDER**

| | |
|-------------------|---------|
| Rated Power Input | 500W |
| Belt Speed | 5-28m/s |
| Belt Size | 9x533mm |
| Net Weight | 1.5kg |

**Features**

Max. sanding depth 110mm, Adjustable speed.

Accessories & Package

Dust Tube Assembly, Abrasive Belt, Carbon Brush, Color Box Packing

**DST533****BELT SANDER**

| | |
|-------------------|-------------|
| Rated Power Input | 550W |
| Belt Speed | 3.3-16.6m/s |
| Belt Size | 30x533mm |
| Net Weight | 2.1kg |

**Features**

Optimum for use in close quarters or on irregular shapes.

Accessories & Package

Abrasive Belt (10pcs) (AP40, AP60, AP80, AP100, AP120), Auxiliary Handle, Carbon Brush, Color Box Packing

**DST610****BELT SANDER**

| | |
|-------------------|-----------|
| Rated Power Input | 1200W |
| Belt Speed | 500m/min |
| Belt Size | 100x610mm |
| Net Weight | 5.8kg |

**Features**

Dust bag design, Suitable for larger area sanding operation.

Accessories & Package

Abrasive Belt (AP80), Dust Bag Assembly, Carbon Brush, Color Box Packing

DSF180

DRYWALL SANDER



| | |
|--------------------|----------------|
| Rated Power Input | 750W |
| No-load Speed | 1500-2700r/min |
| Grinding Disc Dia. | Φ180mm |
| Net Weight | 2.3kg |



Features

1. 360° dead-zone free;
2. Self-vacuum function;
3. Adjustable speed.

Accessories & Package

Auxiliary Handle, Dust Cleaning Hose Assembly, Dust Bag, Cannulate Socket, Abrasive Paper Assembly, Carbon Brush, Color Box Packing

DSF02-225

DRYWALL SANDER



| | |
|----------------------|---------------|
| Rated Power Input | 1050W |
| No-load Speed | 600-2600r/min |
| Grinding Disc Dia. | Φ225mm |
| Telescopic Length | 3.3m |
| Max. Grinding Height | 4.5kg |
| Net Weight | |



Features

1. High power, high speed;
2. LED light strip design, 360° dead-zone free;
3. Self-vacuum function;
4. Backpacking dust collecting bag.

Accessories & Package

Hex Wrench (2pcs), Dust Collection Assembly, Auxiliary Handle, Extension Bar Assembly, Abrasive Paper, Carbon Brush, Carton Packing

DSF04-225

DRYWALL SANDER



| | |
|-----------------------------------|---------------|
| Rated Power Input | 820W |
| No-load Speed | 600-1800r/min |
| Sanding Disc Dia. | Φ215mm |
| Abrasive Paper Dia. | Φ225mm |
| Telescopic Length | 1.0-1.9m |
| Max. Grinding Height | 3.3m |
| Net Weight(without Extension Bar) | 3.5kg |
| Net. Weight(with Extension Bar) | 4.1kg |



Features

1. LED light strip design, 360° dead-zone free;
2. Self-vacuum function;
3. Backpacking dust collecting bag.

Accessories & Package

Hex Wrench, Dust Collection Assembly, Extension Bar Assembly, Abrasive Paper, Backup Ring, Carbon Brush, Carton Packing

DZE110

MARBLE CUTTER



| | |
|-----------------------|------------|
| Rated Power Input | 1200W |
| No-load Speed | 13000r/min |
| Blade Dia. | Φ110mm |
| Max. Cutting Capacity | 30mm |
| Net Weight | 3.0kg |



Features

Trigger switch with lock-on button.

Accessories & Package

Water Pipe, Nozzle, Pipe Connector, Socket Wrench, Wrench, Carbon Brush, Color Box Packing

DZE02-110

MARBLE CUTTER



| | |
|-----------------------|------------|
| Rated Power Input | 1240W |
| No-load Speed | 13000r/min |
| Blade Dia. | Φ110mm |
| Max. Cutting Capacity | 30mm |
| Net Weight | 3.1kg |



Features

1. High overload resistance;
2. Trigger switch with lock-on button.

Accessories & Package

Water Pipe, Nozzle, Pipe Connector, Socket Wrench, Wrench, Carbon Brush, Color Box Packing

DZE02-110B

MARBLE CUTTER



| | |
|-----------------------|------------|
| Rated Power Input | 1240W |
| No-load Speed | 13000r/min |
| Blade Dia. | Φ110mm |
| Max. Cutting Capacity | 30mm |
| Net Weight | 3.1kg |



Features

1. Baseplate has reserved screw holes for fixing;
2. High overload resistance;
3. Trigger switch with lock-on button.

Accessories & Package

Water Pipe, Nozzle, Pipe Connector, Socket Wrench, Wrench, Carbon Brush, Color Box Packing

DZE03-110

MARBLE CUTTER



| | |
|-----------------------|------------|
| Rated Power Input | 1050W |
| No-load Speed | 13300r/min |
| Blade Dia. | Φ110mm |
| Max. Cutting Capacity | 34mm |
| Net Weight | 3.1kg |



Features

1. Max. cutting depth 34mm;
2. Trigger switch with lock-on button.

Accessories & Package

Water Pipe, Nozzle, Pipe Connector, Socket Wrench, Wrench, Carbon Brush, Color Box Packing



DZE05-110**MARBLE CUTTER**

| | |
|-----------------------|------------|
| Rated Power Input | 1600W |
| No-load Speed | 12000r/min |
| Blade Dia. | Φ110mm |
| Max. Cutting Capacity | 30mm |
| Bevel Cutting Angle | 0-45° |
| Net Weight | 3.2kg |

**Features**

1. 1600W high power;
2. 0-45° bevel cutting, Adjustable cutting depth;
3. Anti-splash board design;
4. Trigger switch with lock-on button.

Accessories & Package

Water Pipe, Nozzle, Pipe Connector, Socket Wrench, Wrench, Carbon Brush, Color Box Packing

DZE115**MARBLE CUTTER**

| | |
|-----------------------|------------|
| Rated Power Input | 1200W |
| No-load Speed | 13000r/min |
| Blade Dia. | Φ115mm |
| Max. Cutting Capacity | 30mm |
| Net Weight | 3.0kg |

**Features**

1. Trigger switch with lock-on button.

Accessories & Package

Water Pipe, Nozzle, Pipe Connector, Socket Wrench, Wrench, Carbon Brush, Color Box Packing

DZE02-125**MARBLE CUTTER**

| | |
|-----------------------|------------|
| Rated Power Input | 1240W |
| No-load Speed | 13000r/min |
| Blade Dia. | Φ125mm |
| Max. Cutting Capacity | 39mm |
| Bevel Cutting Angle | 0-45° |
| Net Weight | 3.0kg |

**Features**

1. Fully enclosed guard;
2. Anti-splash board;
3. 0-45° adjustable cutting angle.

Accessories & Package

Water Pipe, Nozzle, Pipe Connector, Socket Wrench, Wrench, Carbon Brush, Color Box Packing

DZE02-180**MARBLE CUTTER**

| | |
|-----------------------|-----------|
| Rated Power Input | 1900W |
| No-load Speed | 5000r/min |
| Blade Dia. | Φ180mm |
| Max. Cutting Capacity | 58mm |
| Net Weight | 7.0kg |

**Features**

1. Overload protection;
2. Soft start, Start smoothly;
3. Trigger switch with lock-on button.

Accessories & Package

Water Pipe, Nozzle, Pipe Connector, Auxiliary Handle, Knob Handle, Socket Wrench, Wrench, Carbon Brush, Color Box Packing

DZE06-110**MARBLE CUTTER**

| | |
|-----------------------|------------|
| Rated Power Input | 1800W |
| No-load Speed | 13500r/min |
| Blade Dia. | Φ110mm |
| Max. Cutting Capacity | 30mm |
| Bevel Cutting Angle | 0-45° |
| Net Weight | 3.3kg |

**Features**

1. 1800W high power;
2. 0-45° bevel cutting, Adjustable cutting depth;
3. Anti-splash board design;
4. Trigger switch with lock-on button.

Accessories & Package

Water Pipe, Nozzle, Pipe Connector, Socket Wrench, Wrench, Carbon Brush, Color Box Packing

DZE125**MARBLE CUTTER**

| | |
|-----------------------|------------|
| Rated Power Input | 1600W |
| No-load Speed | 12000r/min |
| Blade Dia. | Φ125mm |
| Max. Cutting Capacity | 38.5mm |
| Bevel Cutting Angle | 0-45° |
| Net Weight | 3.3kg |

**Features**

1. 1600W high power;
2. 0-45° bevel cutting, Adjustable cutting depth;
3. Anti-splash board design;
4. Trigger switch with lock-on button.

Accessories & Package

Water Pipe, Nozzle, Pipe Connector, Socket Wrench, Wrench, Carbon Brush, Color Box Packing

DZE180**MARBLE CUTTER**

| | |
|-----------------------|-----------|
| Rated Power Input | 1520W |
| No-load Speed | 5000r/min |
| Blade Dia. | Φ180mm |
| Max. Cutting Capacity | 60mm |
| Net Weight | 7.0kg |

**Features**

1. Trigger switch with lock-on button.

Accessories & Package

Water Pipe, Nozzle, Pipe Connector, Auxiliary Handle, Knob Handle, Socket Wrench, Wrench, Carbon Brush, Color Box Packing

DZR110**GROOVE CUTTER**

| | |
|--------------------|------------|
| Rated Power Input | 1600W |
| No-load Speed | 10800r/min |
| Blade Dia. | Φ110mm |
| Max. Cutting Depth | 32mm |
| Max. Cutting Width | 50mm |
| Net Weight | 4.1kg |

**Features**

1. 1600W high power;
2. Dust collecting mouth design, External vacuum cleaner can be connected.

Accessories & Package

Diamond Cutting Disc (Dry Cut) 2pcs, Socket Wrench, Open-end Wrench, Carbon Brush, Color Box Packing

DZR125

GROOVE CUTTER

| | |
|-----------------------|----------------------|
| Rated Power Input | 3000W |
| No-load Speed | 7000r/min |
| Blade Dia. | Φ125mm |
| Max. Cutting Capacity | 39×28mm(Depth×Width) |
| Net Weight | 6.8kg |



Features

1. Groove forming at one time;
2. Soft start, earth leakage protection;
3. Retractable guard;
4. Adjustable grooving depth, External vacuum cleaner can be connected.

Accessories & Package

Diamond Cutting Disc (5pcs), Open-end Wrench, Hex Wrench, Hex Wrench with Cross Recess, Dust Collection Nozzle, Water Pump, Water Pipe, Socket, Gasket, Carbon Brush, Plastic Case Packing

DZR02-150

GROOVE CUTTER

| | |
|--------------------|-----------|
| Rated Power Input | 1400W |
| No-load Speed | 7000r/min |
| Blade Dia. | Φ150mm |
| Max. Cutting Depth | 30mm |
| Max. Cutting Width | 32mm |
| Net Weight | 6.1kg |

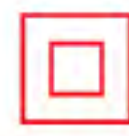

Features

1. Long handle;
2. Adjustable grooving depth and width;
3. The dust collecting mouth, External vacuum cleaner can be connected.

Accessories & Package

Diamond Cutting Disc (150mm Tuck Point) (2pcs), Auxiliary Handle, Special Wrench, Chisel, Carbon Brush, Iron Carrying Packing

DZC02-20

HAMMER DRILL

| | |
|------------------------|----------------|
| Rated Power Input | 500W |
| No-load Speed | 0-850r/min |
| Rated Impact Frequency | 0-3900/min |
| Max. Drilling Capacity | Concrete Φ20mm |
| Net Weight | 2.9kg |



Drill & Hammer

Features

1. Adjustable speed;
2. 2-Mode operation, drill and rotary hammer;
3. SDS-PLUS.

Accessories & Package

Auxiliary Handle, Depth Gauge, Carbon Brush, Plastic Case Packing

DZR135

GROOVE CUTTER

| | |
|--------------------|-----------|
| Rated Power Input | 1500W |
| No-load Speed | 7200r/min |
| Blade Dia. | Φ135mm |
| Max. Cutting Depth | 37mm |
| Net Weight | 3.1kg |



Features

1. Single blade, high power;
2. Soft start, Electronic constant speed control;
3. Overload protection;
4. Left / right 180° rotatable handle.

Accessories & Package

Diamond Cutting Disc, Open-end Wrench, Hex Wrench with Cross Recess, Carbon Brush, Color Box Packing

DZC13

ELECTRIC ROTARY HAMMER

| | |
|------------------------|----------------|
| Rated Power Input | 400W |
| No-load Speed | 0-900r/min |
| Rated Impact Frequency | 0-5600/min |
| Max. Drilling Capacity | Concrete Φ12mm |
| Net Weight | 1.2kg |



Drill & Hammer

Features

1. Light weight, Adjustable speed;
2. 2-Mode operation, drill and rotary hammer;
3. SDS-PLUS.

Accessories & Package

Hammer Drill Bit (8×160mm), Carbon Brush, Color Box Packing

DZC03-26B

ELECTRIC ROTARY HAMMER

| | |
|------------------------|----------------|
| Rated Power Input | 750W |
| No-load Speed | 500r/min |
| Rated Impact Frequency | 3200/min |
| Max. Drilling Capacity | Concrete Φ26mm |
| Net Weight | 5.0kg |



Hammer & Demolition

Features

1. 2-Mode operation, rotary hammer and demolition;
2. SDS-PLUS.

Accessories & Package

Oiler, Dust Cap, O Ring (2pcs), Auxiliary Handle, Depth Gauge, Wrench, Carbon Brush, Plastic Case Packing



DZC05-26**HAMMER DRILL**

| | |
|------------------------|----------------------|
| Rated Power Input | 720W |
| No-load Speed | 0-1200r/min |
| Rated Impact Frequency | 0-4000/min |
| Max. Drilling Capacity | Concrete Φ 26mm |
| Net Weight | 2.93kg |



Drill & Hammer & Demolition

Features

1. Adjustable speed;
2. 3-Mode operation, drill, rotary hammer and demolition;
3. SDS-PLUS.

Accessories & Package

Auxiliary Handle, Depth Gauge, Carbon Brush, Plastic Case Packing

DZC05-26B**HAMMER DRILL**

| | |
|------------------------|----------------------|
| Rated Power Input | 720W |
| No-load Speed | 0-1200r/min |
| Rated Impact Frequency | 0-4000/min |
| Max. Drilling Capacity | Concrete Φ 26mm |
| Net Weight | 2.93kg |



Drill & Hammer & Demolition

Features

1. Adjustable speed, Forward and reverse rotation;
2. 3-Mode operation, drill, rotary hammer and demolition;
3. SDS-PLUS.

Accessories & Package

Auxiliary Handle, Depth Gauge, Carbon Brush, Plastic Case Packing

DZC06-26**HAMMER DRILL**

| | |
|------------------------|----------------------|
| Rated Power Input | 800W |
| No-load Speed | 0-1200r/min |
| Rated Impact Frequency | 0-4600/min |
| Max. Drilling Capacity | Concrete Φ 26mm |
| Net Weight | 2.7kg |



Drill & Hammer & Demolition

Features

1. Adjustable speed, Forward and reverse rotation;
2. 3-Mode operation, drill, rotary hammer and demolition;
3. SDS-PLUS.

Accessories & Package

Auxiliary Handle, Depth Gauge, Carbon Brush, Plastic Case Packing

DZC02-28**ELECTRIC ROTARY HAMMER**

| | |
|------------------------|----------------------|
| Rated Power Input | 960W |
| No-load Speed | 1000r/min |
| Rated Impact Frequency | 5000/min |
| Max. Drilling Capacity | Concrete Φ 28mm |
| Net Weight | 5.0kg |



Hammer & Demolition

Features

1. 2-Mode operation, rotary hammer and demolition;
2. SDS-PLUS.

Accessories & Package

Oil, Dust Cap, O Ring (2pcs), Auxiliary Handle, Depth Gauge, Carbon Brush, Plastic Case Packing

DZC04-30**ELECTRIC ROTARY HAMMER**

| | |
|------------------------|----------------------|
| Rated Power Input | 960W |
| No-load Speed | 1000r/min |
| Rated Impact Frequency | 5000/min |
| Max. Drilling Capacity | Concrete Φ 30mm |
| Net Weight | 5.2kg |



Hammer & Demolition

Features

1. 2-Mode operation, rotary hammer and demolition;
2. SDS-PLUS.

Accessories & Package

Oil, Dust Cap, Auxiliary Handle, Depth Gauge, Carbon Brush, Plastic Case Packing

DZC38**ELECTRIC ROTARY HAMMER**

| | |
|------------------------|----------------------|
| Rated Power Input | 800W |
| No-load Speed | 400r/min |
| Rated Impact Frequency | 3000/min |
| Max. Drilling Capacity | Concrete Φ 38mm |
| Net Weight | 7.6kg |

**Features**

1. Single function: rotary hammer;
2. Hex 13mm.

Accessories & Package

Oil Assembly, Auxiliary Handle, Wrench, Hex Wrench, Carbon Brush, Plastic Case Packing

DZC03-38**ELECTRIC ROTARY HAMMER**

| | |
|------------------------|----------------------|
| Rated Power Input | 1100W |
| No-load Speed | 320r/min |
| Rated Impact Frequency | 2900/min |
| Max. Drilling Capacity | Concrete Φ 38mm |
| Net Weight | 6.2kg |



Hammer & Demolition

Features

1. Safety clutch function;
2. 2-Mode operation, rotary hammer and demolition;
3. SDS-MAX.

Accessories & Package

Auxiliary Handle, Carbon Brush, Plastic Case Packing

DZC45**ELECTRIC ROTARY HAMMER**

| | |
|------------------------|----------------------|
| Rated Power Input | 1500W |
| No-load Speed | 0-305r/min |
| Rated Impact Frequency | 1370-2700/min |
| Max. Drilling Capacity | Concrete Φ 45mm |
| Net Weight | 8.2kg |



Hammer & Demolition

Features

1. Safety clutch function;
2. Soft start, Electronic constant speed control;
3. 2-Mode operation, rotary hammer and demolition;
4. SDS-MAX.

Accessories & Package

Auxiliary Handle, Chuck Oil, Carbon Brush, Plastic Case Packing

DZG6

PERCUSSION HAMMER



| | |
|------------------------|----------|
| Rated Power Input | 1050W |
| Rated Impact Frequency | 2900/min |
| Net Weight | 6.8kg |



Features

1. High quality piston ring;
2. Hex 17mm.

Accessories & Package

Grease, Auxiliary Handle, Special Wrench, Piston Ring, Carbon Brush, Plastic Case Packing

DZG6S

PERCUSSION HAMMER



| | |
|------------------------|----------|
| Rated Power Input | 1050W |
| Rated Impact Frequency | 2900/min |
| Net Weight | 6.8kg |



Features

1. High quality piston rubber ring;
2. Hex 17mm.

Accessories & Package

Grease, Auxiliary Handle, Special Wrench, Carbon Brush, Plastic Case Packing

DZG05-6

PERCUSSION HAMMER



| | |
|------------------------|----------|
| Rated Power Input | 1050W |
| Rated Impact Frequency | 3000/min |
| Net Weight | 5.5kg |



Features

1. Efficient vibration absorbing system;
2. Hex 17mm.

Accessories & Package

Grease, Auxiliary Handle, Carbon Brush, Plastic Case Packing

DZG06-6

PERCUSSION HAMMER



| | |
|------------------------|----------|
| Rated Power Input | 1350W |
| Rated Impact Frequency | 3900/min |
| Net Weight | 6.8kg |



Features

1. 1350W super power;
2. Efficient vibration absorbing system;
3. 35mm diameter cylinder, more destructive;
4. Hex 17mm.

Accessories & Package

Grease, Auxiliary Handle, Special Wrench, Carbon Brush, Plastic Case Packing

DZG10

PERCUSSION HAMMER



| | |
|------------------------|--------------|
| Rated Power Input | 1500W |
| Rated Impact Frequency | 900-1890/min |
| Net Weight | 10.4kg |



Features

1. Adjustable speed;
2. SDS-MAX.

Accessories & Package

Grease, Auxiliary Handle, Hex Wrench, Carbon Brush, Plastic Case Packing

DZG15

PERCUSSION HAMMER



| | |
|------------------------|----------|
| Rated Power Input | 1240W |
| Rated Impact Frequency | 1400/min |
| Net Weight | 16.0kg |



Features

1. Large trigger switch;
2. Hex 30mm.

Accessories & Package

Oiler, Wrench, Hex Wrench, Hex Wrench, Carbon Brush, Iron Carrying Case



DZG02-15**PERCUSSION HAMMER**

| | |
|------------------------|----------|
| Rated Power Input | 1010W |
| Rated Impact Frequency | 1400/min |
| Net Weight | 16.0kg |

**Features**

1. Double insulated;
2. Large trigger switch;
3. Hex 30mm.

Accessories & Package

Oiler, Wrench, Hex Wrench, Hex Wrench, Carbon Brush, Iron Carrying Case

DZG03-15**PERCUSSION HAMMER**

| | |
|------------------------|----------|
| Rated Power Input | 1240W |
| Rated Impact Frequency | 1400/min |
| Net Weight | 16.0kg |

**Features**

1. Large trigger switch;
2. Hex 30mm.

Accessories & Package

Oiler, Wrench, Hex Wrench, Hex Wrench, Carbon Brush, Iron Carrying Case

DZG04-15**PERCUSSION HAMMER**

| | |
|------------------------|----------|
| Rated Power Input | 1520W |
| Rated Impact Frequency | 1450/min |
| Net Weight | 14.3kg |

**Features**

1. 1520W high power;
2. Double insulated;
3. Large trigger switch;
4. Hex 30mm.

Accessories & Package

Carbon Brush, Iron Carrying Case

DZZ90**DIAMOND DRILL WITH WATER SOURCE**

| | |
|------------------------|-------------|
| Rated Power Input | 1350W |
| No-load Speed | 0-2300r/min |
| Max. Drilling Capacity | Φ90mm |
| Net Weight | 4.4kg |

**Features**

1. Light-weight model, Handheld type;
2. Adjustable speed.

Accessories & Package

Water Pipe, Pipe Connector, Open-end Wrench, Auxiliary Handle, Shoulder Support Assembly, Carbon Brush, Plastic Case Packing

DZZ03-110**DIAMOND DRILL WITH WATER SOURCE**

| | |
|------------------------|-----------|
| Rated Power Input | 1800W |
| No-load Speed | 1900r/min |
| Max. Drilling Capacity | |
| Concrete | Φ110mm |
| Brick wall | Φ160mm |
| Net Weight | 5.3kg |

**Features**

1. Light-weight model, Handheld type;
2. No water seal structure design.

Accessories & Package

Water Pipe, Pipe Connector, Open-end Wrench, Auxiliary Handle, Carbon Brush, Plastic Case Packing

DZZ02-130**DIAMOND DRILL WITH WATER SOURCE**

| | |
|------------------------|-----------|
| Rated Power Input | 1800W |
| No-load Speed | 1200r/min |
| Max. Drilling Capacity | Φ130mm |
| Net Weight | 11.6kg |

**Features**

Light-weight model, Convenient operation.

Accessories & Package

Water Pipe, Pipe Connector, Open-end Wrench, Hex Wrench (2pcs), Carbon Brush, Carton Packing

DZZ02-160**DIAMOND DRILL WITH WATER SOURCE**

| | |
|------------------------|-----------|
| Rated Power Input | 1800W |
| No-load Speed | 1900r/min |
| Max. Drilling Capacity | Φ160mm |
| Net Weight | 5.2kg |

**Features**

Light-weight model, Handheld type.

Accessories & Package

Water Pipe, Pipe Connector, Open-end Wrench, Auxiliary Handle, Shoulder Support Assembly, Carbon Brush, Plastic Case Packing

DZZ03-160**DIAMOND DRILL WITH WATER SOURCE**

| | |
|------------------------|-----------|
| Rated Power Input | 1800W |
| No-load Speed | 1900r/min |
| Max. Drilling Capacity | Φ160mm |
| Net Weight | 11.7kg |

**Features**

Dual-use, handheld and vertical type.

Accessories & Package

Water Pipe, Pipe Connector, Open-end Wrench, Hex Wrench, Auxiliary Handle, Carbon Brush, Carton Packing



DZZ02-180

DIAMOND DRILL WITH WATER SOURCE

| | |
|------------------------|-----------|
| Rated Power Input | 2000W |
| No-load Speed | 1900r/min |
| Max. Drilling Capacity | Φ180mm |
| Net Weight | 6.2kg |



Features

1. Light-weight model, Handheld type;
2. No water seal structure design.

Accessories & Package

Water Pipe, Pipe Connector, Open-end Wrench, Auxiliary Handle, Carbon Brush, Plastic Case Packing

DZZ190

DIAMOND DRILL WITH WATER SOURCE

| | |
|-------------------|------------------------|
| Rated Power Input | 1800W |
| No-load Speed | Max. Drilling Capacity |
| Gear1 Brick wall | Φ110-190mm 750r/min |
| Gear2 Brick wall | Φ65-110mm 1650r/min |
| Gear3 Brick wall | Φ15-65mm 3300r/min |
| Net Weight | 6.0kg |



Features

1. 3-speed mechanical speed control;
2. Oil lubrication;
3. Light-weight model, Handheld type.

Accessories & Package

Water Pipe, Pipe Connector, Open-end Wrench, Auxiliary Handle, Carbon Brush, Plastic Case Packing

DZZ200S

DIAMOND DRILL WITH WATER SOURCE

| | |
|------------------------|----------|
| Rated Power Input | 3300W |
| No-load Speed | 500r/min |
| Max. Drilling Capacity | Φ200mm |
| Net Weight | 22.0kg |



Features

Earth leakage protection.

Accessories & Package

Water Pipe, Pipe Connector, Hex Wrench (3pcs), Carbon Brush, Carton Packing

DZZ02-200S

DIAMOND DRILL WITH WATER SOURCE

| | |
|------------------------|----------|
| Rated Power Input | 3500W |
| No-load Speed | 700r/min |
| Max. Drilling Capacity | Φ200mm |
| Net Weight | 25.0kg |



Features

Earth leakage protection.

Accessories & Package

Water Pipe, Pipe Connector, Open-end Wrench, Hex Wrench (3pcs), Carbon Brush, Carton Packing

DZZ02-200SA

DIAMOND DRILL WITH WATER SOURCE

| | |
|------------------------|----------|
| Rated Power Input | 3500W |
| No-load Speed | 700r/min |
| Max. Drilling Capacity | Φ200mm |
| Net Weight | 25.5kg |



Features

1. With roller bracket;
2. Earth leakage protection.

Accessories & Package

Water Pipe, Pipe Connector, Open-end Wrench, Hex Wrench (3pcs), Hex Wrench 4, Carbon Brush, Carton Packing

DZZ250

DIAMOND DRILL WITH WATER SOURCE

| | |
|------------------------|----------|
| Rated Power Input | 3800W |
| No-load Speed | 580r/min |
| Max. Drilling Capacity | Φ250mm |
| Net Weight | 25.0kg |



Features

1. 3800W high power;
2. Overload protection;
3. Earth leakage protection.

Accessories & Package

Water Pipe, Pipe Connector, Open-end Wrench, Hex Wrench (3pcs), Carbon Brush, Carton Packing

DZZ250A**DIAMOND DRILL WITH WATER SOURCE**

| | |
|------------------------|----------|
| Rated Power Input | 3800W |
| No-load Speed | 580r/min |
| Max. Drilling Capacity | Φ250mm |
| Net Weight | 25.5kg |

**Features**

1. 3800W high power with roller bracket;
2. Overload protection;
3. Earth leakage protection.

Accessories & Package

Water Pipe, Pipe Connector, Open-end Wrench, Hex Wrench (3pcs) , Carbon Brush, Carton Packing

DZZ02-250**DIAMOND DRILL WITH WATER SOURCE**

| | |
|------------------------|---------------|
| Rated Power Input | 3800W |
| No-load Speed | 390/1100r/min |
| Max. Drilling Capacity | Φ250mm |
| Net Weight | 25.0kg |

**Features**

1. 3800W high power;
2. 2-speed mechanical speed control and Overload protection;
3. Earth leakage protection.

Accessories & Package

Water Pipe, Pipe Connector, Open-end Wrench, Hex Wrench (3pcs), Carbon Brush, Carton Packing

DZZ02-250A**DIAMOND DRILL WITH WATER SOURCE**

| | |
|------------------------|---------------|
| Rated Power Input | 3800W |
| No-load Speed | 390/1100r/min |
| Max. Drilling Capacity | Φ250mm |
| Net Weight | 25.5kg |

**Features**

1. 3800W high power with roller bracket;
2. 2-speed mechanical speed control and Overload protection;
3. Earth leakage protection.

Accessories & Package

Water Pipe, Pipe Connector, Open-end Wrench, Hex Wrench (3pcs), Carbon Brush, Carton Packing

DZJ10**ELECTRIC IMPACT DRILL**

| | |
|------------------------|---|
| Rated Power Input | 500W |
| No-load Speed | 0-2500r/min |
| Rated Impact Frequency | 0-37500/min |
| Max. Drilling Capacity | Steel Φ8mm Concret Φ10mm Wood Φ20mm |
| Net Weight | 1.6kg |

**Features**

Adjustable speed, Forward and reverse rotation.

Accessories & Package

Auxiliary Handle, Depth Gauge, Chuck Wrench, Carbon Brush, Color Box Packing

DZJ02-13**ELECTRIC IMPACT DRILL**

Optional: Keyless Chuck   

| | |
|------------------------|--|
| Rated Power Input | 500W |
| No-load Speed | 0-2600r/min |
| Rated Impact Frequency | 0-41600/min |
| Max. Drilling Capacity | Steel Φ10mm Concret Φ13mm Wood Φ25mm |
| Net Weight | 2.0kg |



 Drill & Impact Drill

Features

1. Half structure;
2. Two functions: drill and impact Drill;
3. Adjustable speed, Forward and reverse rotation.

Accessories & Package

Auxiliary Handle, Depth Gauge, Chuck Wrench, Carbon Brush, Color Box Packing

DZJ03-13**ELECTRIC IMPACT DRILL**

| | |
|------------------------|--|
| Rated Power Input | 500W |
| No-load Speed | 0-1450r/min |
| Rated Impact Frequency | 0-18850/min |
| Max. Drilling Capacity | Steel Φ13mm Concret Φ13mm Wood Φ20mm |
| Net Weight | 2.5kg |

**Features**

Adjustable speed, Forward and reverse rotation.

Accessories & Package

Auxiliary Handle, Depth Gauge, Chuck Wrench, Carbon Brush, Color Box Packing

DZJ05-13**ELECTRIC IMPACT DRILL**

| | |
|------------------------|--|
| Rated Power Input | 710W |
| No-load Speed | 0-3000r/min |
| Rated Impact Frequency | 0-45000/min |
| Max. Drilling Capacity | Steel Φ13mm Concret Φ16mm Wood Φ30mm |
| Net Weight | 2.0kg |



 Drill & Impact Drill

Features

1. 710W high power;
2. Two functions: drill and impact Drill;
3. All aluminum gear box, Rubber-covered handle;
4. Adjustable speed, Forward and reverse rotation.

Accessories & Package

Auxiliary Handle, Depth Gauge, Chuck Wrench, Carbon Brush, Color Box Packing

DZJ16**ELECTRIC IMPACT DRILL**

| | |
|------------------------|--|
| Rated Power Input | 710W |
| No-load Speed | 0-3000r/min |
| Rated Impact Frequency | 0-45000/min |
| Max. Drilling Capacity | Steel Φ13mm Concret Φ16mm Wood Φ30mm |
| Net Weight | 2.0kg |



 Drill & Impact Drill

Features

1. 710W high power;
2. Two functions: drill and impact Drill;
3. High strength plastic gear box, Rubber-covered handle;
4. Adjustable speed, Forward and reverse rotation.

Accessories & Package

Auxiliary Handle, Depth Gauge, Chuck Wrench, Carbon Brush, Color Box Packing

DZJ20

ELECTRIC IMPACT DRILL



| | | |
|------------------------|-----------|-------------|
| Rated Power Input | 720W | |
| No-load Speed | Low Speed | High Speed |
| | 0-1150 | 0-2800r/min |
| Rated Impact Frequency | 0-23000 | 0-56000/min |
| Max. Drilling Capacity | Steel | Φ8mm |
| | Concret | Φ20mm |
| | Wood | Φ25mm |
| Net Weight | 2.4kg | |



Drill & Impact Drill

Features

- 2-speed mechanical speed control;
- Rubber-covered handle;
- Adjustable speed, Forward and reverse rotation.

Accessories & Package

Auxiliary Handle, Depth Gauge, Chuck Wrench, Carbon Brush, Color Box Packing

DZJ04-13

ELECTRIC IMPACT DRILL(TOOL KIT)



| | | |
|------------------------|-------------|-------|
| Rated Power Input | 500W | |
| No-load Speed | 0-2600r/min | |
| Rated Impact Frequency | 0-41600/min | |
| Max. Drilling Capacity | Steel | Φ10mm |
| | Concret | Φ13mm |
| | Wood | Φ25mm |



Features

Match different hand tools and accessories, suitable for various applications.

Accessories & Package

Hammer Drill Bit Set, Twist Drill Bit Set, Woodworking Drill Set, Level Ruler, Screwdriver Bit Set, Vice, Adjustable Wrench, Claw Hammer, Screwdriver, Screw Socket Set, Utility Knife, Tape Measure 3m, Auxiliary Handle, Depth Gauge, Chuck Wrench, Carbon Brush, Plastic Case Packing

DJZ02-6A

ELECTRIC DRILL



| | | |
|------------------------|-------------|--------|
| Rated Power Input | 230W | |
| No-load Speed | 0-3800r/min | |
| Max. Drilling Capacity | Steel | Φ6.5mm |
| | Wood | Φ9mm |
| Net Weight | 1.2kg | |



Optional: Keyless Chuck

Features

Stepless speed control, Forward and reverse rotation.

Accessories & Package

Depth Gauge Assembly, Chuck Wrench (Key Chuck Optional), Carbon Brush, Color Box Packing

DJZ03-6

ELECTRIC DRILL



| | | |
|------------------------|-------------|--------|
| Rated Power Input | 420W | |
| No-load Speed | 0-4200r/min | |
| Max. Drilling Capacity | Steel | Φ6.5mm |
| | Wood | Φ15mm |
| Net Weight | 1.0kg | |



Features

- 420W high power;
- Ergonomic body design, small and compact;
- Stepless speed control, Forward and reverse rotation.

Accessories & Package

Chuck Wrench, Carbon Brush, Color Box Packing

DJZ03-6K

ELECTRIC DRILL



| | | |
|------------------------|-------------|--------|
| Rated Power Input | 420W | |
| No-load Speed | 0-4200r/min | |
| Max. Drilling Capacity | Steel | Φ6.5mm |
| | Wood | Φ15mm |
| Net Weight | 1.0kg | |



Features

- 420W high power;
- Ergonomic body design, small and compact;
- Stepless speed control, Forward and reverse rotation.

Accessories & Package

Carbon Brush, Color Box Packing

DJZ10A

ELECTRIC DRILL



| | | |
|------------------------|-------------|-------|
| Rated Power Input | 300W | |
| No-load Speed | 0-3000r/min | |
| Max. Drilling Capacity | Steel | Φ10mm |
| | Wood | Φ18mm |
| Net Weight | 1.5kg | |



Optional: Keyless Chuck

Features

Adjustable speed, Forward and reverse rotation.

Accessories & Package

Twist Drill Bit (3.2mm), Chuck Wrench (Key Chuck Optional), Carbon Brush, Color Box Packing

DJZ05-10A

ELECTRIC DRILL



| | | |
|------------------------|-------------|-------|
| Rated Power Input | 500W | |
| No-load Speed | 0-2600r/min | |
| Max. Drilling Capacity | Steel | Φ10mm |
| | Wood | Φ25mm |
| Net Weight | 1.7kg | |



Optional: Keyless Chuck

Features

Adjustable speed, Forward and reverse rotation.

Accessories & Package

Twist Drill Bit (3.2mm), Chuck Wrench (Key Chuck Optional), Carbon Brush, Color Box Packing

DJZ06-10

ANGLE DRILL



| | | |
|------------------------|-------------|-------|
| Rated Power Input | 380W | |
| No-load Speed | 0-1400r/min | |
| Max. Drilling Capacity | Steel | Φ10mm |
| | Wood | Φ15mm |
| Net Weight | 1.9kg | |



Features

- Angular structure design, Easy to use in narrow space;
- Large paddle switch.

Accessories & Package

Auxiliary Handle, Chuck Wrench, Carbon Brush, Color Box Packing



DJZ07-10

ELECTRIC DRILL



| | |
|------------------------|-------------|
| Rated Power Input | 500W |
| No-load Speed | 0-1750r/min |
| Max. Drilling Capacity | |
| Steel | Φ10mm |
| Wood | Φ25mm |
| Net Weight | 1.5kg |



Optional: Keyless Chuck

Features

1. Double-gear drive, high torque output;
2. Adjustable speed, Forward and reverse rotation.

Accessories & Package

Twist Drill Bit (3.2mm) (2pcs) , Chuck Wrench (Key Chuck Optional), Carbon Brush, Color Box Packing

DJZ08-10

ELECTRIC DRILL



| | |
|------------------------|------------|
| Rated Power Input | 250W |
| No-load Speed | 0-850r/min |
| Torque Setting | 16+1 |
| Max. Drilling Capacity | |
| Steel | Φ10mm |
| Wood | Φ20mm |
| Net Weight | 1.2kg |



Features

1. Torque adjustment function;
2. Rubber-covered handle;
3. Stepless speed control, Forward and reverse rotation.

Accessories & Package

Carbon Brush, Color Box Packing

DJZ09-10

ELECTRIC DRILL



| | |
|------------------------|-------------|
| Rated Power Input | 710W |
| No-load Speed | 0-2800r/min |
| Max. Drilling Capacity | |
| Steel | Φ10mm |
| Wood | Φ20mm |
| Net Weight | 1.6kg |



Features

1. 710W high power;
2. Ergonomics body design;
3. Stepless speed control, Forward and reverse rotation.

Accessories & Package

Chuck Wrench, Carbon Brush, Color Box Packing

DJZ09-10K

ELECTRIC DRILL



| | |
|------------------------|-------------|
| Rated Power Input | 710W |
| No-load Speed | 0-2800r/min |
| Max. Drilling Capacity | |
| Steel | Φ10mm |
| Wood | Φ20mm |
| Net Weight | 1.6kg |



Features

1. 710W high power;
2. Ergonomics body design;
3. Stepless speed control, Forward and reverse rotation.

Accessories & Package

Carbon Brush, Color Box Packing

DJZ10-10

ELECTRIC DRILL



| | |
|------------------------|-------------|
| Rated Power Input | 460W |
| No-load Speed | 0-3200r/min |
| Max. Drilling Capacity | |
| Steel | Φ10mm |
| Wood | Φ25mm |
| Net Weight | 1.3kg |



Features

1. Ergonomics body design;
2. Stepless speed control, Forward and reverse rotation.

Accessories & Package

Chuck Wrench, Carbon Brush, Color Box Packing

DJZ10-10K

ELECTRIC DRILL



| | |
|------------------------|-------------|
| Rated Power Input | 460W |
| No-load Speed | 0-3200r/min |
| Max. Drilling Capacity | |
| Steel | Φ10mm |
| Wood | Φ25mm |
| Net Weight | 1.3kg |



Features

1. Ergonomics body design;
2. Stepless speed control, Forward and reverse rotation.

Accessories & Package

Carbon Brush, Color Box Packing

DJZ11-10

ELECTRIC DRILL

| | |
|------------------------|-------------|
| Rated Power Input | 400W |
| No-load Speed | 0-3800r/min |
| Max. Drilling Capacity | |
| Steel | Φ10mm |
| Wood | Φ20mm |
| Net Weight | 1.1kg |



Features

1. 400W high power;
2. Ergonomic body design, small and compact;
3. Stepless speed control, Forward and reverse rotation.

Accessories & Package

Chuck Wrench, Carbon Brush, Color Box Packing

DJZ11-10K

ELECTRIC DRILL

| | |
|------------------------|-------------|
| Rated Power Input | 400W |
| No-load Speed | 0-3800r/min |
| Max. Drilling Capacity | |
| Steel | Φ10mm |
| Wood | Φ20mm |
| Net Weight | 1.1kg |



Features

1. 400W high power;
2. Ergonomic body design, small and compact;
3. Stepless speed control, Forward and reverse rotation.

Accessories & Package

Carbon Brush, Color Box Packing

DJZ02-13

ELECTRIC DRILL

| | |
|------------------------|-------------|
| Rated Power Input | 500W |
| No-load Speed | 0-1450r/min |
| Max. Drilling Capacity | |
| Steel | Φ13mm |
| Wood | Φ20mm |
| Net Weight | 2.4kg |



Optional: Keyless Chuck

Features

1. Adjustable speed, Forward and reverse rotation.

Accessories & Package

Auxiliary Handle, Depth Gauge, Chuck Wrench, Carbon Brush, Color Box Packing

DJZ03-13B

ELECTRIC DRILL

| | |
|------------------------|----------|
| Rated Power Input | 800W |
| No-load Speed | 850r/min |
| Max. Drilling Capacity | |
| Steel | Φ13mm |
| Wood | Φ36mm |
| Net Weight | 2.9kg |



Features

1. Fixed speed, High torque;
2. 360 ° rotatable D-shape handle.

Accessories & Package

Auxiliary Handle, Chuck Wrench, Carbon Brush, Color Box Packing

DJZ06-13

ELECTRIC DRILL

| | |
|------------------------|-------------|
| Rated Power Input | 710W |
| No-load Speed | 0-2800r/min |
| Max. Drilling Capacity | |
| Steel | Φ13mm |
| Wood | Φ20mm |
| Net Weight | 1.7kg |



Features

1. 710W high power;
2. Ergonomics body design;
3. Stepless speed control, Forward and reverse rotation.

Accessories & Package

Chuck Wrench, Carbon Brush, Color Box Packing

DJZ06-13K

ELECTRIC DRILL

| | |
|------------------------|-------------|
| Rated Power Input | 710W |
| No-load Speed | 0-2800r/min |
| Max. Drilling Capacity | |
| Steel | Φ13mm |
| Wood | Φ20mm |
| Net Weight | 1.7kg |



Features

1. 710W high power;
2. Ergonomics body design;
3. Stepless speed control, Forward and reverse rotation.

Accessories & Package

Carbon Brush, Color Box Packing

DJZ07-13

ELECTRIC DRILL

| | |
|------------------------|------------|
| Rated Power Input | 710W |
| No-load Speed | 0-900r/min |
| Max. Drilling Capacity | |
| Steel | Φ13mm |
| Wood | Φ38mm |
| Net Weight | 2.4kg |



Features

1. Double-gear drive, high torque output;
2. Adjustable speed, Forward and reverse rotation.

Accessories & Package

Auxiliary Handle, Chuck Wrench, Carbon Brush, Color Box Packing

DJZ16A

ELECTRIC DRILL

| | |
|------------------------|----------|
| Rated Power Input | 800W |
| No-load Speed | 680r/min |
| Max. Drilling Capacity | |
| Steel | Φ16mm |
| Wood | Φ36mm |
| Net Weight | 3.2kg |

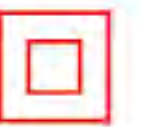

Features

1. Fixed speed, High torque;
2. 360 ° rotatable D-shape handle.

Accessories & Package

Auxiliary Handle, Chuck Wrench, Carbon Brush, Color Box Packing

DJZ03-16A

ELECTRIC DRILL

| | |
|------------------------|----------|
| Rated Power Input | 1010W |
| No-load Speed | 620r/min |
| Max. Drilling Capacity | |
| Steel | Φ16mm |
| Wood | Φ36mm |
| Net Weight | 3.2kg |



Features

1. 1010W high power;
2. Fixed speed, High torque;
3. 360 ° rotatable D-shape handle.

Accessories & Package

Auxiliary Handle, Chuck Wrench, Carbon Brush, Color Box Packing

DJZ03-16B

ELECTRIC DRILL

| | |
|------------------------|----------|
| Rated Power Input | 1010W |
| No-load Speed | 620r/min |
| Max. Drilling Capacity | |
| Steel | Φ16mm |
| Wood | Φ36mm |
| Net Weight | 3.2kg |



Features

1. 1010W high power, Forward and reverse rotation;
2. Fixed speed, High torque;
3. 360 ° rotatable D-shape handle.

Accessories & Package

Auxiliary Handle, Chuck Wrench, Carbon Brush, Color Box Packing

DJS10

TAPPER

| | |
|-------------------------------|-------------|
| Rated Power Input | 500W |
| No-load Speed | |
| Forward | 0-580r/min |
| Backward | 0-1000r/min |
| Tapping Capacity | |
| Cast Iron, Aluminum or Copper | M4-M12mm |
| Steel | M4-M10mm |
| Net Weight | 2.5kg |



Features

1. Autocorrection function;
2. Adjustable speed, Automatic reverse exit.

Accessories & Package

Auxiliary Handle, Depth Gauge, Hex Wrench, Carbon Brush, Color Box Packing

DJS02-10

TAPPER

| | |
|-------------------------------|-------------|
| Rated Power Input | 500W |
| No-load Speed | |
| Forward | 0-580r/min |
| Backward | 0-1000r/min |
| Tapping Capacity | |
| Cast Iron, Aluminum or Copper | M4-M12mm |
| Steel | M4-M10mm |
| Net Weight | 2.6kg |



Features

Adjustable speed, Automatic reverse exit.

Accessories & Package

Auxiliary Handle, Depth Gauge, Chuck Wrench, Carbon Brush, Color Box Packing

DJC16

MAGNETIC DRILL

| | |
|------------------------|-----------|
| Rated Power Input | 900W |
| Max. Drilling Capacity | Φ16mm |
| Magnetism | 11500N |
| No-load Speed | 450r/min |
| Max. Stroke | 140mm |
| Connector | Mt2 Shank |
| Net Weight | 11.5kg |



Features

1. Twist drill only;
2. Fuse overload protection.

Accessories & Package

Safety Belt, Open-end Wrench, Hex Wrench, Drill Chuck Wrench, Fuse, Carbon Brush, Plastic Case Packing

DJC23

MAGNETIC DRILL

| | |
|------------------------|-----------|
| Rated Power Input | 1500W |
| Max. Drilling Capacity | |
| Twist Drill Bit | Φ23mm |
| Core Drill Bit | Φ50mm |
| Magnetism | 15000N |
| No-load Speed | 390r/min |
| Max. Stroke | 220mm |
| Connector | Mt2 Shank |
| Net Weight | 21.0kg |



Features

1. Two functions: twist Drill and core Drill;
2. Fuse overload protection.

Accessories & Package

Core Drill Bit (22mm), Core Drill Bit Joint Assembly, Wedge Iron, Safety Belt, Hex Wrench (2pcs), Drill Chuck Wrench, Drill Chuck, Extension Rod for Morse Taper Bush with Tang, Fuse, Oiler Assembly, Carbon Brush, Iron Carrying Case

DJC23S

MAGNETIC DRILL

| | |
|------------------------|-----------|
| Rated Power Input | 1500W |
| Max. Drilling Capacity | |
| Twist Drill Bit | Φ23mm |
| Magnetism | 15000N |
| No-load Speed | 390r/min |
| Max. Stroke | 220mm |
| Connector | Mt2 Shank |
| Net Weight | 21.0kg |



Features

1. Twist drill only;
2. Fuse overload protection.

Accessories & Package

Wedge Iron, Safety Belt, Hex Wrench (2pcs), Fuse, Carbon Brush, Iron Carrying Case

DJC02-23

MAGNETIC DRILL

| | |
|------------------------|----------------------|
| Rated Power Input | 1600W |
| Max. Drilling Capacity | |
| Twist Drill Bit | Φ23mm |
| Core Drill Bit | Φ50mm |
| Max. Tapping Capacity | M20(Sold Separately) |
| Magnetism | 15000N |
| No-load Speed | 130-260/260-520r/min |
| Max. Stroke | 220mm |
| Connector | Mt3 Shank |
| Net Weight | 24.0kg |



Features

1. Triple function: Twist Drill, Core Drill and Tapping;
2. Soft start, 2-speed mechanical speed control;
3. Electronic constant speed control, maintains constant speed under load;
4. Electronic overload protection, safety release clutch.

Accessories & Package

Joint Assembly for MT3 Core, Wedge Iron, Safety Belt, Open-end Wrench, Hex Wrench (2pcs), Chuck Wrench, Drill Chuck, Extension Rod for Morse Taper Bush with Tang, Center Pin, Long Center Pin, Short Center Pin, Morse Reduction Sleeve, Oiler Assembly, Carbon Brush, Iron Carrying Case

DJC30

MAGNETIC DRILL(CORE DRILL)

| | |
|------------------------|---------------------|
| Rated Power Input | 900W |
| Max. Drilling Capacity | Φ30mm |
| Max. Drilling Depth | 35mm |
| Magnetism | 11500N |
| No-load Speed | 450r/min |
| Max. Stroke | 140mm |
| Connector | Straight ShankΦ19mm |
| Net Weight | 11.5kg |



Features

1. Core Drill only;
2. Fuse overload protection.

Accessories & Package

Core Drill Bit (22mm), Safety Belt, Open-end Wrench, Hex Wrench (2pcs), Fuse, Carbon Brush, Plastic Case Packing

DJC02-30

MAGNETIC DRILL

| | |
|------------------------|----------|
| Rated Power Input | 900W |
| Max. Drilling Capacity | |
| Twist Drill Bit | Φ13mm |
| Core Drill Bit | Φ30mm |
| Magnetism | 11500N |
| No-load Speed | 450r/min |
| Max. Stroke | 140mm |
| Net Weight | 12.0kg |



Features

1. Two functions: core drill and twist drill;
2. Fuse overload protection.

Accessories & Package

Core Drill Bit (22mm), Core Drill Bit Joint Assembly, Safety Belt, Open-end Wrench, Double Open-end Wrench, Hex Wrench (2pcs), Chuck Wrench, Drill Chuck, Protecting Set, Fuse, Oiler Assembly, Carbon Brush, Plastic Case Packing

DJB3

WELD JOINT BEVELLER

| | |
|-------------------|-----------------|
| Rated Power Input | 800W |
| No-load Speed | 9000r/min |
| Blade Size | □9.5×3.5×Φ4.2mm |
| Net Weight | 2.5kg |



Features

1. Suitable for chamfering outside joint;
2. Rear toggle switch.

Accessories & Package

Auxiliary Handle, Hex Wrench (3pcs), Carbon Brush, Color Box Packing

DJB02-3

WELD JOINT BEVELLER

| | |
|-------------------|-----------------|
| Rated Power Input | 800W |
| No-load Speed | 9000r/min |
| Blade Size | □9.5×3.5×Φ4.2mm |
| Net Weight | 2.3kg |



Features

1. Suitable for chamfering inside joint;
2. Slide switch.

Accessories & Package

Auxiliary Handle, Hex Wrench, Carbon Brush, Color Box Packing

DJJ25

ELECTRIC SHEAR

| | |
|-------------------------|----------|
| Rated Power Input | 710W |
| No-load Strokes | 2200/min |
| Max. Cutting Capacities | |
| Mild Steel | 2.5mm |
| Hard Steel | 2.0mm |
| Stainless Steel | 2.0mm |
| Aluminum Plate | 3.2mm |
| Min. Cutting Radius | 45mm |
| Net Weight | 2.3kg |



Features

1. 710W high power;
2. Shearing smoothly.

Accessories & Package

Hex Wrench, Gauge, Carbon Brush, Color Box Packing

DJJ32

ELECTRIC SHEAR

| | |
|-------------------------|----------|
| Rated Power Input | 710W |
| No-load Strokes | 1600/min |
| Max. Cutting Capacities | |
| Mild Steel | 3.2mm |
| Hard Steel | 2.5mm |
| Stainless Steel | 2.5mm |
| Aluminum Plate | 4.0mm |
| Min. Cutting Radius | 50mm |
| Net Weight | 3.8kg |



Features

1. 710W high power;
2. D-shape handle, convenient for long time shearing.

Accessories & Package

Hex Wrench, Gauge, Carbon Brush, Color Box Packing

DJH32

ELECTRIC NIBBLER

| | |
|-------------------------|----------|
| Rated Power Input | 620W |
| No-load Strokes | 1300/min |
| Max. Cutting Capacities | |
| Mild Steel | 3.2mm |
| Stainless Steel | 2.5mm |
| Min. Cutting Radius | |
| Inner Dia. | 120mm |
| Outer Dia. | 128mm |
| Net Weight | 3.8kg |



Features

1. D-shape handle, convenient for long time shearing ;
2. Punch-cutting smoothly.

Accessories & Package

Spacer Shim, Wrench, Carbon Brush, Color Box Packing

DJF30

RECIPROCATING SAW

| | |
|-----------------------|------------|
| Rated Power Input | 590W |
| No-load Strokes | 0-2300/min |
| Length of Strokes | 30mm |
| Max. Cutting Capacity | |
| Steel | 90mm |
| Wood | 90mm |
| Net Weight | 3.2kg |



Features

1. Rubber-covered front;
2. Adjustable speed.

Accessories & Package

Saw Blade 21, Saw Blade 22, Saw Blade 23, Hex Wrench, Carbon Brush, Plastic Case Packing



DJG02-355

ELECTRIC CUT-OFF MACHINE

| | |
|----------------------|--------------|
| Rated Power Input | 2000W |
| No-load Speed | 3800r/min |
| Wheel Size | 355x3x25.4mm |
| Miter Cutting Angle | 0~45° |
| Max.Cutting Capacity | |
| Round Bar | 65mm |
| Pipe | 120mm |
| Profiled Bar | 120x130mm |
| Net Weight | 16.0kg |



Features

1. Aluminum housing;
2. Thickened and reinforced base design.

Accessories & Package

Wrench, Carbon Brush, Color Box Packing

DJG02-355S

ELECTRIC CUT-OFF MACHINE

| | |
|----------------------|--------------|
| Rated Power Input | 2200W |
| No-load Speed | 3800r/min |
| Wheel Size | 355x3x25.4mm |
| Miter Cutting Angle | 0~45° |
| Max.Cutting Capacity | |
| Round Bar | 65mm |
| Pipe | 120mm |
| Profiled Bar | 120x130mm |
| Net Weight | 16.0kg |



Features

1. Power improved to 2200W;
2. Aluminum housing;
3. Thickened and reinforced base design.

Accessories & Package

Wrench, Carbon Brush, Color Box Packing

DJG03-355

ELECTRIC CUT-OFF MACHINE

| | |
|----------------------|--------------|
| Rated Power Input | 2100W |
| No-load Speed | 3900r/min |
| Wheel Size | 355x3x25.4mm |
| Miter Cutting Angle | 0~45° |
| Max.Cutting Capacity | |
| Round Bar | 65mm |
| Pipe | 120mm |
| Profiled Bar | 120x130mm |
| Net Weight | 16.0kg |



Features

1. Aluminum housing.

Accessories & Package

Wrench, Carbon Brush, Color Box Packing

DJG04-355S

ELECTRIC CUT-OFF MACHINE

| | |
|----------------------|--------------|
| Rated Power Input | 2200W |
| No-load Speed | 3800r/min |
| Wheel Size | 355x3x25.4mm |
| Miter Cutting Angle | 0~45° |
| Max.Cutting Capacity | |
| Pipe | 100mm |
| Profiled Bar | 120x130mm |
| Net Weight | 15.6kg |



Features

1. 2200W high power;
2. Aluminum housing;
3. D-shape handle for easy gripping.

Accessories & Package

Wrench, Carbon Brush, Color Box Packing

DJG04-355BS

ELECTRIC CUT-OFF MACHINE

| | |
|----------------------|--------------|
| Rated Power Input | 2200W |
| No-load Speed | 3800r/min |
| Wheel Size | 355x3x25.4mm |
| Miter Cutting Angle | 0~45° |
| Max.Cutting Capacity | |
| Pipe | 100mm |
| Profiled Bar | 95x120mm |
| Net Weight | 18.6kg |



Features

1. 2200W high power;
2. Sealing guard, Aluminum housing;
3. D-shape handle for easy gripping.

Accessories & Package

Wrench, Carbon Brush, Color Box Packing

DJG05-400

ELECTRIC CUT-OFF MACHINE

| | |
|----------------------|-------------------|
| Rated Power Input | 3000W |
| No-load Speed | 2840r/min |
| Wheel Size | 400x3.2x32mm |
| Miter Cutting Angle | 0~45° |
| Max.Cutting Capacity | |
| Steel Tube Φ135x6mm | Round Steel Φ50mm |
| Angle Steel 100x10mm | U-steel 120x53mm |
| Net Weight | 66.0kg |



Features

1. Casting body;
2. Finish milling base.

Accessories & Package

Wooden Case Packing

D3JG03-400

ELECTRIC CUT-OFF MACHINE

| | |
|----------------------|-------------------|
| Rated Power Input | 3000W |
| No-load Speed | 2800r/min |
| Wheel Size | 400x3.2x32mm |
| Miter Cutting Angle | 0~45° |
| Max.Cutting Capacity | |
| Steel Tube Φ135x6mm | Round Steel Φ50mm |
| Angle Steel 100x10mm | U-steel 120x53mm |
| Net Weight | 63.0kg |



Features

1. 380V, Three-phase motor;
2. Cast body.

Accessories & Package

Wooden Case Packing

DJX255

ELECTRIC MITRE SAW

| | |
|--------------------|-----------|
| Rated Power Input | 1650W |
| No-load Speed | 4600r/min |
| Hole Dia. of Blade | Φ25.4mm |
| Blade Dia. | 255mm |
| Net Weight | 12.0kg |

| Max. Cutting Capacity (HxW) | Miter Angle | 0° | | 45° |
|-----------------------------|-------------|---------|---------|----------------|
| | Bevel Angle | | | Left and Right |
| 0° | 0° | 93x95mm | 93x67mm | 69x95mm |
| | 45°Left | 53x95mm | 49x67mm | 35x94mm |



Features

1. Precision machined aluminum base;
2. Dust bag for a cleaner work environment;
3. Gear drive structure.

Accessories & Package

Vertical Vise, Holder Assembly (2pcs), Dust Bag Assembly, Socket Wrench, Triangle Ruler, Carbon Brush, Color Box Packing

DJX03-255

ELECTRIC MITRE SAW

| | |
|--------------------|-----------|
| Rated Power Input | 1650W |
| No-load Speed | 6000r/min |
| Hole Dia. of Blade | Φ25.4mm |
| Blade Dia. | 255mm |
| Net Weight | 12.0kg |

| Max. Cutting Capacity (HxW) | Miter Angle | 0° | | 45° |
|-----------------------------|-------------|----------|---------|----------------|
| | Bevel Angle | | | Left and Right |
| 0° | 0° | 60x130mm | 60x93mm | |
| | 45°Left | 45x130mm | 45x93mm | |



Features

1. Precision machined aluminum base;
2. Dust bag for a cleaner work environment;
3. Belt drive structure.

Accessories & Package

Vertical Vise, Dust Bag Assembly, Socket Wrench, Triangle Ruler, Carbon Brush, Color Box Packing

DJX03-255B

ELECTRIC MITRE SAW

| | |
|--------------------|-----------|
| Rated Power Input | 1650W |
| No-load Speed | 6000r/min |
| Hole Dia. of Blade | Φ25.4mm |
| Blade Dia. | 255mm |
| Net Weight | 11.6kg |

| Max. Cutting Capacity (HxW) | Miter Angle | 0° | | 45° |
|-----------------------------|-------------|----------|----------|----------------|
| | Bevel Angle | | | Left and Right |
| 0° | 0° | 60x130mm | 60x93mm | |
| | 45°Left | 49x315mm | 49x223mm | |



Features

1. Economical model, no bevel angle cutting and no brake function;
2. Belt drive structure;
3. High precision chassis design, miters 0-45°left and right.

Accessories & Package

Dust Bag Assembly, Socket Wrench, Triangle Ruler, Carbon Brush, Color Box Packing

DJX06-255

ELECTRIC MITRE SAW

| | |
|--------------------|-----------|
| Rated Power Input | 1650W |
| No-load Speed | 4600r/min |
| Hole Dia. of Blade | Φ25.4mm |
| Blade Dia. | 255mm |
| Net Weight | 18.5kg |

| Max. Cutting Capacity (HxW) | Miter Angle | 0° | | 45° |
|-----------------------------|-------------|----------|----------|----------------|
| | Bevel Angle | | | Left and Right |
| 0° | 0° | 94x95mm | 94x223mm | |
| | 45°Left | 49x315mm | 49x223mm | |



Features

1. Double sliding structures which lead to greater cutting range and higher cutting accuracy;
2. Dust collecting mouth design, External vacuum cleaner available;
3. Gear drive structure.

Accessories & Package

Vertical Vise, Holder Assembly (2pcs), Dust Bag Assembly, Socket Wrench, Triangle Ruler, Carbon Brush, Color Box Packing

DJX07-255

ELECTRIC MITRE SAW

| | |
|--------------------|-----------|
| Rated Power Input | 1200W |
| No-load Speed | 6000r/min |
| Hole Dia. of Blade | Φ25.4mm |
| Blade Dia. | 255mm |
| Net Weight | 11.0kg |

| Max. Cutting Capacity (HxW) | Miter Angle | 0° | | 45° |
|-----------------------------|-------------|----------|----------|----------------|
| | Bevel Angle | | | Left and Right |
| 0° | 0° | 56x145mm | 56x110mm | |
| | 45°Left | 56x110mm | | |



Features

1. Economical model, no bevel angle cutting and no brake function;
2. High precision base design, miters 0-45°left and right;
3. Belt drive structure.

Accessories & Package

Dust Bag Assembly, Socket Wrench, Plastic Case Packing

DJX305

ELECTRIC MITRE SAW

| | |
|--------------------|-----------|
| Rated Power Input | 1250W |
| No-load Speed | 5000r/min |
| Hole Dia. of Blade | Φ30mm |
| Blade Dia. | 305mm |
| Net Weight | 15.8kg |

| Max. Cutting Capacity (HxW) | Miter Angle | 0° | | 45° |
|-----------------------------|-------------|----------|----------|----------------|
| | Bevel Angle | | | Left and Right |
| 0° | 0° | 90x150mm | 90x110mm | |
| | 45°Left | 90x110mm | | |



Features

1. Precision machined aluminum base;
2. Belt drive structure.

Accessories & Package

Vertical Vise, Dust Bag Assembly, Socket Wrench, Carton Packing

DMB82

ELECTRIC PLANER

| | |
|--------------------|------------|
| Rated Power Input | 500W |
| No-load Speed | 16000r/min |
| Max. Planing Width | 82mm |
| Max. Planing Depth | 1mm |
| Net Weight | 2.9kg |



Features

Planing smoothly.

Accessories & Package

Sharpening Holder Assembly, Blade Gauge, Socket Wrench, Guide plate Assembly, Carbon Brush, Color Box Packing

DMB02-82

ELECTRIC PLANER

| | |
|--------------------|------------|
| Rated Power Input | 500W |
| No-load Speed | 15000r/min |
| Max. Planing Width | 82mm |
| Max. Planing Depth | 1mm |
| Net Weight | 2.6kg |



Features

Planing smoothly.

Accessories & Package

Sharpening Holder Assembly, Blade Gauge, Socket Wrench, Guide Plate Assembly, Fastening Bolt, Carbon Brush, Color Box Packing



DMB03-82

ELECTRIC PLANER

| | |
|------------------------|------------|
| Rated Power Input | 500W |
| No-load Speed | 16000r/min |
| Max. Planing Width | 82mm |
| Max. Planing Depth | 1mm |
| Max. Shiplapping Depth | 23mm |
| Net Weight | 2.9kg |



Features

1. Max shiplapping depth is 23mm;
2. Planing smoothly.

Accessories & Package

Sharpening Holder Assembly, Blade Gauge, Socket Wrench, Guide Plate Assembly, Carbon Brush, Color Box Packing

DMB110

ELECTRIC PLANER

| | |
|--------------------|------------|
| Rated Power Input | 840W |
| No-load Speed | 16500r/min |
| Max. Planing Width | 110mm |
| Max. Planing Depth | 2mm |
| Net Weight | 4.2kg |



Features

1. Max single planing depth is 2mm;
2. Planing smoothly.

Accessories & Package

Sharpening Holder Assembly, Blade Gauge, Socket Wrench, Carbon Brush, Color Box Packing

DMP6

TRIMMER

| | |
|--------------------------|------------|
| Rated Power Input | 440W |
| No-load Speed | 31000r/min |
| Max. Milling Cutter Dia. | Φ6.35mm |
| Net Weight | 1.7kg |



Features

1. Durable aluminum housing;
2. Transparent acrylic base.

Accessories & Package

Wrench (2pcs), Straight Guide, Templet Guide, Trimmer Guide Assembly, Carbon Brush, Color Box Packing

DMP02-6

TRIMMER

| | |
|--------------------------|------------|
| Rated Power Input | 350W |
| No-load Speed | 30000r/min |
| Max. Milling Cutter Dia. | Φ6.35mm |
| Net Weight | 1.8kg |



Features

Transparent acrylic base.

Accessories & Package

Wrench (2pcs), Straight Guide, Templet Guide, Trimmer Guide Assembly, Carbon Brush, Color Box Packing

DMP03-6

TRIMMER

| | |
|--------------------------|------------|
| Rated Power Input | 530W |
| No-load Speed | 30000r/min |
| Max. Milling Cutter Dia. | Φ6.35mm |
| Net Weight | 1.8kg |



Features

1. 530W high power;
2. Transparent acrylic base.

Accessories & Package

Wrench (2pcs), Straight Guide, Templet Guide, Trimmer Guide Assembly, Carbon Brush, Color Box Packing

DMP04-6

TRIMMER

| | |
|--------------------------|------------|
| Rated Power Input | 550W |
| No-load Speed | 30000r/min |
| Max. Milling Cutter Dia. | Φ6.35mm |
| Net Weight | 1.6kg |



Features

1. 550W high power;
2. Durable aluminum housing;
3. Transparent acrylic base.

Accessories & Package

Wrench (2pcs), Straight Guide, Templet Guide, Trimmer Guide Assembly, Carbon Brush, Color Box Packing

DMP04-6B

TRIMMER

| | |
|--------------------------|------------|
| Rated Power Input | 550W |
| No-load Speed | 30000r/min |
| Max. Milling Cutter Dia. | Φ6.35mm |
| Net Weight | 1.8kg |

NEW



Features

1. 550W high power;
2. Base with adjustable bevel trimming angle around 0-45°;
3. Durable aluminum housing.

Accessories & Package

Wrench (2pcs), Carbon Brush, Color Box Packing

DMR8

WOOD ROUTER

| | |
|--------------------------|------------|
| Rated Power Input | 900W |
| No-load Speed | 26000r/min |
| Max. Milling Cutter Dia. | Φ8mm |
| Net Weight | 2.9kg |



Features

Powerful motor delivers smooth routing.

Accessories & Package

Wrench (2pcs), Straight Guide Assembly, Collet Cone, Carbon Brush, Color Box Packing

DMR02-12

WOOD ROUTER

| | |
|--------------------------|------------|
| Rated Power Input | 1850W |
| No-load Speed | 22000r/min |
| Max. Milling Cutter Dia. | Φ12.7mm |
| Net Weight | 6.0kg |



Features

1850W high power.

Accessories & Package

Wrench (2pcs), Straight Guide, Retainer Base Assembly, Templet Guide, Trimmer Guide Assembly, Collet (6.35mm), Collet (9.52mm), Carbon Brush, Color Box Packing

DMR04-12

WOOD ROUTER

| | |
|--------------------------|------------|
| Rated Power Input | 1850W |
| No-load Speed | 22000r/min |
| Max. Milling Cutter Dia. | Φ12.7mm |
| Net Weight | 6.0kg |



Features

1850W high power, higher work efficiency.

Accessories & Package

Wrench (2pcs), Straight Guide, Retainer Base Assembly, Templet Guide, Trimmer Guide Assembly, Collet (6.35mm), Collet (9.52mm), Carbon Brush, Color Box Packing



DMR12

WOOD ROUTER

| | |
|--------------------------|------------|
| Rated Power Input | 1600W |
| No-load Speed | 23000r/min |
| Max. Milling Cutter Dia. | Φ12.7mm |
| Net Weight | 6.0kg |



Features

Powerful motor delivers smooth routing.

Accessories & Package

Wrench (2pcs), Straight Guide, Retainer Base Assembly, Templet Guide, Trimmer Guide Assembly, Collet (6.35mm), Collet (9.52mm), Carbon Brush, Color Box Packing

DMR03-12

WOOD ROUTER

| | |
|--------------------------|------------|
| Rated Power Input | 1050W |
| No-load Speed | 23000r/min |
| Max. Milling Cutter Dia. | Φ12.7mm |
| Net Weight | 3.5kg |

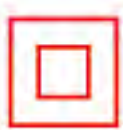

Features

Robust base with rotation ring depth adjustment.

Accessories & Package

Wrench (2pcs), Straight Guide Assembly, Templet Guide, Trimmer Guide Assembly, Collet (6.35mm), Collet (9.52mm), Carbon Brush, Color Box Packing

DMR05-12

WOOD ROUTER

| | |
|--------------------------|------------|
| Rated Power Input | 1240W |
| No-load Speed | 24000r/min |
| Max. Milling Cutter Dia. | Φ12.7mm |
| Net Weight | 4.6kg |



Features

Robust base with rotation ring depth adjustment.

Accessories & Package

Wrench, Straight Guide Assembly, Templet Guide, Trimmer Guide Assembly, Collet (6.35mm), Collet (9.52mm), Carbon Brush, Color Box Packing

DMD320

MULTI-TOOL

| | |
|-----------------------|-----------------|
| Rated Power Input | 320W |
| Speed Shifting Gears | 6(1-2-3-4-5-6) |
| Oscillation Angle | 3° |
| Oscillation Frequency | 11000-20000/min |
| Net Weight | 1.3kg |



Features

1. Match different accessories, widely applications;
2. 6-speed, Electronic constant speed control;
3. Rubber-covered body.

Accessories & Package

Adaptor for Tool Holder, HCS Plunge Cut Saw Blade, BIM Plunge Cut Saw Blade, Segment Saw Blade, Scraper, Sanding plate, Abrasive Paper (12pcs) (P60, P80, P120, P240), Hex Wrench, File Holder Assembly, Plastic Case Packing



DMQ65

JIG SAW

| | |
|-----------------------|-------------------------|
| Rated Power Input | 600W |
| No-load Strokes | 500-3000/min |
| Bevel Cutting Angle | 0-45° Left/Right |
| Max. Cutting Capacity | Steel 10mm Wood 65mm |
| Net Weight | 2.5kg |



Features

1. 600W high power;
2. Straight plus 3 orbital settings;
3. 6-Speed, 0-45° bevel cutting angle.

Accessories & Package

Protective Guard, Saw Blade (3pcs) (T144D, T111C, T118A), Hex Wrench, Anti-cracking Baseplate, Plastic Liner Panel, Carbon Brush, Color Box Packing

DMQ65K

JIG SAW

| | |
|-----------------------|-------------------------|
| Rated Power Input | 600W |
| No-load Strokes | 500-3000/min |
| Bevel Cutting Angle | 0-45° Left/Right |
| Max. Cutting Capacity | Steel 10mm Wood 65mm |
| Net Weight | 2.5kg |



Features

1. 600W high power;
2. Quick change chuck system;
3. Straight plus 3 orbital settings;
4. 6-Speed, 0-45° bevel cutting angle.

Accessories & Package

Saw Blade (3pcs) (T144D, T111C, T118A), Hex Wrench, Anti-cracking Baseplate, Plastic Liner Panel, Carbon Brush, Color Box Packing

DMQ85

JIG SAW

| | |
|-----------------------|-------------------------|
| Rated Power Input | 580W |
| No-load Strokes | 500-3100/min |
| Bevel Cutting Angle | 0-45° Left/Right |
| Max. Cutting Capacity | Steel 10mm Wood 85mm |
| Net Weight | 2.7kg |



Features

1. Aluminum gear box for higher durability;
2. Straight plus 3 orbital settings;
3. 6-Speed, 0-45° bevel cutting angle.

Accessories & Package

Saw Blade (3pcs) (T144D, T111C, T118A), Screwdriver, Hex Wrench, Blade Gauge, Plastic Base, Carbon Brush, Color Box Packing

DMY185

ELECTRIC CIRCULAR SAW

| | |
|-----------------------|-----------|
| Rated Power Input | 1100W |
| No-load Speed | 4900r/min |
| Blade Dia. | 185mm |
| Max. Cutting Capacity | 64mm |
| Max. Cutting Angle | 45° |
| Net Weight | 5.0kg |



Features

Adjustable bevel cutting angle around 0-45°.

Accessories & Package

Hex Wrench, Fixing Plate, Carbon Brush, Color Box Packing

DMY02-185

ELECTRIC CIRCULAR SAW

| | |
|-----------------------|-----------|
| Rated Power Input | 1100W |
| No-load Speed | 5600r/min |
| Blade Dia. | 185mm |
| Max. Cutting Capacity | 64mm |
| Max. Cutting Angle | 45° |
| Net Weight | 3.6kg |



Features

light-weight model, adjustable bevel cutting angle around 0-45°.

Accessories & Package

Hex Wrench, Fixing Plate, Auxiliary Handle, Hex Socket Head Screw, Handle Connecting Plate, Carbon Brush, Color Box Packing

DMY03-185

ELECTRIC CIRCULAR SAW

| | |
|-----------------------|-----------|
| Rated Power Input | 1400W |
| No-load Speed | 5300r/min |
| Blade Dia. | 185mm |
| Max. Cutting Capacity | 64mm |
| Max. Cutting Angle | 45° |
| Net Weight | 5.0kg |



Features

1. 1400W high power;
2. light-weight model, adjustable bevel cutting angle around 0-45°.

Accessories & Package

Hex Wrench, Fixing Plate, Carbon Brush, Color Box Packing

DMY03-185S

ELECTRIC CIRCULAR SAW



| | |
|-----------------------|-----------|
| Rated Power Input | 1500W |
| No-load Speed | 5300r/min |
| Blade Dia. | 185mm |
| Max. Cutting Capacity | 64mm |
| Max. Cutting Angle | 45° |
| Net Weight | 4.0kg |



Features

1. 1500W high power;
2. light-weight model, adjustable bevel cutting angle around 0-45°.

Accessories & Package

Hex Wrench, Fixing Plate, Carbon Brush, Color Box Packing



DMY235

ELECTRIC CIRCULAR SAW



| | |
|-----------------------|-----------|
| Rated Power Input | 1520W |
| No-load Speed | 4100r/min |
| Blade Dia. | 235mm |
| Max. Cutting Capacity | 84mm |
| Max. Cutting Angle | 45° |
| Net Weight | 7.5kg |



Features

Adjustable bevel cutting angle around 0-45°.

Accessories & Package

Wrench, Fixing Plate, Auxiliary Handle, Carbon Brush, Color Box Packing

DMY02-235

ELECTRIC CIRCULAR SAW



| | |
|-----------------------|----------------------|
| Rated Power Input | 2000W |
| No-load Speed | 4100r/min |
| Blade Dia. | 235mm |
| Max. Cutting Capacity | 90° 85mm 45° 60mm |
| Max. Cutting Angle | 50° |
| Net Weight | 6.5kg |



Features

1. 2000W high power;
2. light-weight model, adjustable bevel cutting angle around 0-45°.

Accessories & Package

Hex Wrench, Fixing Plate, Carbon Brush, Color Box Packing

DML405

ELECTRIC CHAIN SAW



| | |
|--------------------------|----------|
| Rated Power Input | 1300W |
| No-load Speed | 400m/min |
| Max. Length of Guide Bar | 405mm |
| Net Weight | 6.0kg |



Features

1. Manual oil pumping;
2. High quality saw chain.

Accessories & Package

Saw Chain, Guide Bar, Socket Wrench, File, Cross Screwdriver, Olier, Carbon Brush, Color Box Packing

DML03-405

ELECTRIC CHAIN SAW



| | |
|--------------------------|----------|
| Rated Power Input | 1300W |
| No-load Speed | 400m/min |
| Max. Length of Guide Bar | 405mm |
| Net Weight | 5.6kg |



Features

1. Economical model;
2. Manua oil pumping.

Accessories & Package

Saw Chain, Guide Bar, Socket Wrench, Cross Screwdriver, Olier, Carbon Brush, Color Box Packing

DML04-405

ELECTRIC CHAIN SAW



| | |
|--------------------------|----------|
| Rated Power Input | 1800W |
| No-load Speed | 800m/min |
| Max. Length of Guide Bar | 405mm |
| Net Weight | 4.5kg |



Features

1. 1800W high power;
2. 800m/min high speed cutting;
3. Safety braking function, Soft start;
4. Automatic oil pumping.

Accessories & Package

Saw Chain, Guide Bar, Link Plate Cover, Socket Wrench, Fixed Collar, File, Cross Screwdriver, Olier, Carbon Brush, Color Box Packing

DML05-405

ELECTRIC CHAIN SAW



| | |
|--------------------------|----------|
| Rated Power Input | 1900W |
| No-load Speed | 480m/min |
| Max. Length of Guide Bar | 405mm |
| Net Weight | 4.3kg |



Features

1. 1900W high power;
2. Tool- free guide bar;
3. Automatic oil pumping.

Accessories & Package

Saw Chain, Guide Bar, Socket Screwdriver, Carbon Brush, Plastic Case Packing

DFF02-150

DUST-FREE SAW

| | |
|-----------------------|-------------|
| Rated Power Input | 1400W |
| No-load Speed | 5300r/min |
| Blade Dia. | Φ105-Φ150mm |
| Fan Rated Power | 1000W |
| Maximum Vacuum Degree | 24000Pa |
| Net Weight | 11.9kg |



Features

1. Efficient dust extraction;
2. Lightweight and flexible.

Accessories & Package

Saw Blade, Dust bag, Protective Cover, Large Wrench, Hex Wrench, Socket Wrench, Angle Adjusting Diagram Assembly, Tool Bag, Carbon Brush, Carton Packing

DFF03-150

DUST-FREE SAW

| | |
|-----------------------|-------------|
| Rated Power Input | 1100W |
| No-load Speed | 4900r/min |
| Blade Dia. | Φ125-Φ150mm |
| Fan Rated Power | 1000W |
| Maximum Vacuum Degree | 21000Pa |
| Net Weight | 10.0kg |



Features

1. Hard aluminum worktop;
2. Efficient dust extraction;
3. Lightweight and flexible.

Accessories & Package

Saw Blade, Dust bag, Protective Cover, L-shaped Socket Wrench, Screwdriver, Angle Adjusting Diagram Assembly, Backpack, Carbon Brush, Carton Packing

DPL6

SCREWDRIVER

| | |
|---------------------|-------------|
| Rated Power Input | 710W |
| No-load Speed | 0-4300r/min |
| Max. Screw Dia. | |
| Drywall Screw | 5mm |
| Self Drilling Screw | 6mm |
| Net Weight | 1.6kg |



Features

1. Suitable for various drywall and framing applications;
2. Aluminum gear box;
3. Adjustable screw-in depth.

Accessories & Package

Cross Screwdrive Bit (2pcs), Carbon Brush, Color Box Packing

DPL8

IMPACT SCREWDRIVER

| | |
|------------------------|-------------|
| Rated Power Input | 300W |
| No-load Speed | 0-2200r/min |
| Rated Impact Frequency | 0-3000/min |
| Max. Torque | 98N·m |
| Net Weight | 1.3kg |



Features

1. Adjustable speed, Forward and reverse rotation;
2. Rubber-covered handle.

Accessories & Package

Double Cross Screwdrive Bit, Carbon Brush, Color Box Packing

DPB12

ELECTRIC WRENCH

| | |
|------------------------|-------------|
| Rated Power Input | 300W |
| No-load Speed | 1800r/min |
| Rated Impact Frequency | 2000/min |
| Capacities(Bolt Size) | M8-M12mm |
| Square Drive | 12.7x12.7mm |
| Max. Fastening Torque | 188N·m |
| Net Weight | 2.1kg |



Features

1. Metal gear box;
2. Rocker type reversing switch.

Accessories & Package

Socket 18x12.5L, Socket Pin, O Ring, Carbon Brush, Color Box Packing

DPB16

ELECTRIC WRENCH

| | |
|------------------------|-------------|
| Rated Power Input | 450W |
| No-load Speed | 1800r/min |
| Rated Impact Frequency | 2000/min |
| Capacities(Bolt Size) | M10-M16mm |
| Square Drive | 12.7x12.7mm |
| Max. Fastening Torque | 240-300N·m |
| Net Weight | 2.6kg |



Features

1. Metal gear box;
2. Rocker type reversing switch.

Accessories & Package

Socket 24x12.5L, Socket Pin, O Ring, Carbon Brush, Color Box Packing



DPB20C

ELECTRIC WRENCH

| | |
|------------------------|-------------|
| Rated Power Input | 340W |
| No-load Speed | 1700r/min |
| Rated Impact Frequency | 2000/min |
| Capacities(Bolt Size) | M12-M20mm |
| Square Drive | 12.7x12.7mm |
| Max. Fastening Torque | 294N·m |
| Net Weight | 3.2kg |



Features

1. Rubber-covered front;
2. Metal gear box;
3. Rocker type reversing switch.

Accessories & Package

Socket 24x12.5L, Socket Pin, O Ring, Carbon Brush, Plastic Case Packing

DPB22C

ELECTRIC WRENCH

| | |
|------------------------|-----------|
| Rated Power Input | 620W |
| No-load Speed | 1700r/min |
| Rated Impact Frequency | 1600/min |
| Capacities(Bolt Size) | M16-M22mm |
| Square Drive | 19x19mm |
| Max. Fastening Torque | 588N·m |
| Net Weight | 5.0kg |



Features

1. Rubber-covered front;
2. Metal gear box;
3. Rocker type reversing switch.

Accessories & Package

Socket 32x19L, Socket Pin, O Ring, Auxiliary Handle Assembly, Carbon Brush, Plastic Case Packing

DPB30

ELECTRIC WRENCH

| | |
|------------------------|-------------|
| Rated Power Input | 1050W |
| No-load Speed | 1400r/min |
| Rated Impact Frequency | 1500/min |
| Capacities(Bolt Size) | M24-M30mm |
| Square Drive | 25.4x25.4mm |
| Max. Fastening Torque | 400-900N·m |
| Net Weight | 10.0kg |



Features

1. Maximum output torque 900N.m;
2. Rubber-covered front;
3. Meta gear box;
4. Rocker type reversing switch.

Accessories & Package

Socket 36mm, Socket Pin, O Ring, Auxiliary Handle Assembly, Carbon Brush, Plastic Case Packing

DPB24E

SHEAR WRENCH

| | |
|-----------------------|---------|
| Rated Power Input | 1050W |
| No-load Speed | 18r/min |
| Max. Fastening Torque | 1100N·m |
| Net Weight | 8.0kg |

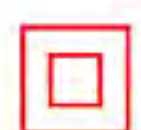

Features

1. M16、M20、M22、M24, various sleeve assemblies are available;
2. Maximum output torque 1100N·m.

Accessories & Package

Outer Socket, Inner Socket Assembly, Carbon Brush, Iron Carrying Case

DQB02-1600

HEAT GUN

| | |
|-------------------|--------------|
| Rated Power Input | 1600W |
| Temperature | |
| Low Temperature | 50-400 °C |
| High Temperature | 50-550 °C |
| Air Flow | |
| Low Temperature | 190-210L/min |
| High Temperature | 310-350L/min |
| Net Weight | 0.8kg |



Features

- 2-gear adjustable temperature and air flow.

Accessories & Package

Flat Wind Tube, Round Wind Tube, Color Box Packing

DQB03-1600

HEAT GUN

| | |
|--------------------|--------------|
| Rated Voltage | 110V |
| Rated Power Input | 1600W |
| Temperature | |
| Low Temperature | 50 °C |
| Middle Temperature | 50-400 °C |
| High Temperature | 50-550 °C |
| Air Flow | |
| Low Temperature | 190-210L/min |
| Middle Temperature | 190-210L/min |
| High Temperature | 310-350L/min |
| Net Weight | 0.8kg |

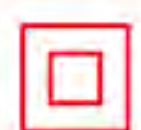

Features

1. Rated voltage 110V;
2. 3-gear adjustable temperature and air flow.

Accessories & Package

Flat Wind Tube, Round Wind Tube, Color Box Packing

DQB2000

HEAT GUN

| | |
|-------------------|--------------|
| Rated Power Input | 2000W |
| Temperature | |
| Low Temperature | 50-480 °C |
| High Temperature | 50-600 °C |
| Air Flow | |
| Low Temperature | 210-250L/min |
| High Temperature | 340-380L/min |
| Net Weight | 0.8kg |



Features

- 2-gear adjustable temperature and air flow.

Accessories & Package

Flat Wind Tube, Round Wind Tube, Color Box Packing

DQB03-2000

HEAT GUN

| | |
|--------------------|-----------|
| Rated Power Input | 2000W |
| Temperature | |
| Low Temperature | 50 °C |
| Middle Temperature | 50-630 °C |
| High Temperature | 50-630 °C |
| Air Flow | |
| Low Temperature | 300L/min |
| Middle Temperature | 300L/min |
| High Temperature | 500L/min |
| Net Weight | 0.7kg |



Features

1. 3-gear adjustable temperature and air flow;
2. With digital display.

Accessories & Package

Flat Wind Tube, Round Wind Tube, Color Box Packing



DQB04-2000

HEAT GUN

| | |
|--------------------|--------------|
| Rated Power Input | 2000W |
| Temperature | |
| Low Temperature | 50 C |
| Middle Temperature | 50-480 C |
| High Temperature | 50-600 C |
| Air Flow | |
| Low Temperature | 210-250L/min |
| Middle Temperature | 210-250L/min |
| High Temperature | 340-380L/min |
| Net Weight | 0.8kg |



Features

1. 3-gear adjustable temperature and air flow;
2. Rubber-covered handle.

Accessories & Package

Flat Wind Tube, Round Wind Tube, Color Box Packing

DQF25

BLOWER VACUUM

| | |
|-------------------|------------|
| Rated Power Input | 480W |
| No-load Speed | 14000r/min |
| Air Volumee | 2.5m³/min |
| Net Weight | 1.8kg |



Features

Dust bag design.

Accessories & Package

Blowpipe Assembly, Dust Bag Assembly, Carbon Brush, Color Box Packing

DQF32

BLOWER VACUUM

| | |
|-------------------|-----------------|
| Rated Power Input | 680W |
| No-load Speed | 8300-16300r/min |
| Air Volumee | 1.6-3.2m³/min |
| Net Weight | 1.8kg |



Features

Adjustable speed, Dust bag design.

Accessories & Package

Blowpipe Assembly, Dust Bag Assembly, Carbon Brush, Color Box Packing

DVC15

VACUUM CLEANER

| | |
|-------------------|---------|
| Rated Power Input | 1200W |
| Capacity | 15L |
| Cooling System | Recycle |
| Net Weight | 7.6kg |



Features

Wet / Dry HEPA Filter.

Accessories & Package

Dust Cleaning Brush, Water Cleaning Brush, Sofa Cleaning Piece, Flat Suction Nozzle, Round Brush, Telescopic Steel Pipe, Vacuum Hose, Long Joint for Steel Pipe, Hose Connection Assembly, Carton Packing

DVC30

VACUUM CLEANER

| | |
|-------------------|---------|
| Rated Power Input | 1200W |
| Capacity | 30L |
| Cooling System | Recycle |
| Net Weight | 8.8kg |



Features

Wet / Dry HEPA Filter.

Accessories & Package

Dust Cleaning Brush, Water Cleaning Brush, Flat Suction Nozzle, Round Brush, Curved Steel Pipe (2pcs), Vacuum Hose, Long Joint for Steel Pipe, Hose Connection, Carton Packing

DVC60

VACUUM CLEANER

| | |
|-------------------|---------|
| Rated Power Input | 2300W |
| Capacity | 60L |
| Cooling System | Recycle |
| Net Weight | 24.0kg |



Features

Wet / Dry HEPA Filter.

Accessories & Package

Dust Cleaning Brush, Water Cleaning Brush, Flat Suction Nozzle, Round Brush, Curved Steel Pipe (2pcs), Vacuum Hose, Long Joint for Steel Pipe, Hose Connection, Carton Packing

DVC80

VACUUM CLEANER

| | |
|-------------------|---------|
| Rated Power Input | 3200W |
| Capacity | 80L |
| Cooling System | Recycle |
| Net Weight | 26.5kg |



Features

Wet / Dry HEPA Filter.

Accessories & Package

Dust Cleaning Brush, Water Cleaning Brush, Flat Suction Nozzle, Round Brush, Curved Steel Pipe (2pcs), Vacuum Hose, Long Joint for Steel Pipe, Hose Connection, Carton Packing

DQW5.5/7 PLUS

HIGH-PRESSURE WASHER

| | |
|--------------------------|----------|
| Rated Power Input | 1200W |
| Rated Operating Pressure | 70Bar |
| Water Temperature Input | 0-40 °C |
| Rated Flow | 5.5L/min |
| Net Weight | 7.6kg |



Features

1. Suitable for home use;
2. Self-priming, Asynchronous machine.

Accessories & Package

High-Pressure Tube (10m), High Pressure Water Gun, High Pressure Cleaning Pot, Inlet Pipe (3m), Water Filter Assembly, Water Tap Connector, Nozzle Cleaner, O Ring, Color Box Packing

DQW5.5/10

HIGH-PRESSURE WASHER

| | |
|--------------------------|----------|
| Rated Power Input | 1600W |
| Rated Operating Pressure | 100Bar |
| Rated Flow | 5.5L/min |
| Net Weight | 8.5kg |



Features

1. Suitable for home use;
2. Self-priming, Asynchronous machine.

Accessories & Package

High-Pressure Tube (10m), High Pressure Water Gun, High Pressure Cleaning Pot, Inlet Pipe (5m), Water Filter Assembly, Water Tap Connector, Nozzle Cleaner, Color Box Packing

DQW8/7

HIGH-PRESSURE WASHER

| | |
|--------------------------|--------|
| Rated Power Input | 1600W |
| Rated Operating Pressure | 70Bar |
| Rated Flow | 8L/min |
| Net Weight | 23.0kg |



Features

1. Suitable for commercial use;
2. Self-priming, Asynchronous machine.

Accessories & Package

High-Pressure Tube (10m), Inlet Pipe (2m), Water Filter Assembly, High Pressure Water Gun, Vulnerable Parts Kits, Carton Packing

DQW10/7

HIGH-PRESSURE WASHER

| | |
|--------------------------|---------|
| Rated Power Input | 2000W |
| Rated Operating Pressure | 70Bar |
| Rated Flow | 10L/min |
| Net Weight | 35.5kg |



Features

1. Suitable for commercial use;
2. Self-priming, Asynchronous machine.

Accessories & Package

High-Pressure Tube (10m), Inlet Pipe (3m), Water Filter Assembly, High Pressure Water Gun, Nozzle (4pcs), Vulnerable Parts Kits, Carton Packing

DQW11/9.5

HIGH PRESSURE WASHER

| | |
|--------------------------|---------|
| Rated Power Input | 2800W |
| Rated Operating Pressure | 95Bar |
| Rated Flow | 11L/min |
| Net Weight | 48.5kg |



Features

1. Suitable for commercial use;
2. Self-priming, Asynchronous machine.

Accessories & Package

High-Pressure Tube (10m), Inlet Pipe (3m), Water Filter Assembly, High Pressure Water Gun, Nozzle (4pcs), Vulnerable Parts Kits, Carton Packing

DQW9/12.5

HIGH PRESSURE WASHER

| | |
|--------------------------|--------|
| Rated Power Input | 3000W |
| Rated Operating Pressure | 125Bar |
| Rated Flow | 9L/min |
| Net Weight | 50.0kg |



Features

1. Suitable for commercial use;
2. Self-priming, Asynchronous machine.

Accessories & Package

High-Pressure Tube (10m), Inlet Pipe (3m), Water Filter Assembly, High Pressure Water Gun, Nozzle (4pcs), Vulnerable Parts Kits, Carton Packing

DQU120×2

ELECTRIC MIXER

| | |
|-----------------------------|------------|
| Rated Power Input | 1400W |
| No-load Speed | 0-700r/min |
| Stirring Paddle Dia. | 120mm |
| Stirring Paddle Thread Dia. | M27×1.5 |
| Net Weight | 4.8kg |



Features

1. Ergonomic frame handle;
2. Adjustable speed, Double stirrer.

Accessories & Package

Stirring Paddle Assembly, Carbon Brush, Open-end Wrench (2pcs), Color Box Packing

DQU160

ELECTRIC MIXER

| | |
|-----------------------------|----------|
| Rated Power Input | 800W |
| No-load Speed | 680r/min |
| Stirring Paddle Dia. | 160mm |
| Stirring Paddle Thread Dia. | M12 |
| Net Weight | 2.4kg |



Features

- Two stirring paddles are available.

Accessories & Package

Stirring Paddle Assembly, Auxiliary Handle, Carbon Brush, Color Box Packing

DQU160B**ELECTRIC MIXER**

| | |
|-----------------------------|----------|
| Rated Power Input | 800W |
| No-load Speed | 680r/min |
| Stirring Paddle Dia. | 160mm |
| Stirring Paddle Thread Dia. | M12 |
| Net Weight | 2.4kg |

**Features**

Two stirring paddles are optional.

Accessories & Package

Stirring Paddle Assembly, Auxiliary Handle, Carbon Brush, Color Box Packing

DQU02-160**ELECTRIC MIXER**

| | |
|-----------------------------|----------|
| Rated Power Input | 1010W |
| No-load Speed | 620r/min |
| Stirring Paddle Dia. | 160mm |
| Stirring Paddle Thread Dia. | M12 |
| Net Weight | 3.5kg |

**Features**

Two stirring paddles are optional.

Accessories & Package

Stirring Paddle Assembly, Auxiliary Handle, Carbon Brush, Color Box Packing

DQU02-160B**ELECTRIC MIXER**

| | |
|-----------------------------|----------|
| Rated Power Input | 1010W |
| No-load Speed | 620r/min |
| Stirring Paddle Dia. | 160mm |
| Stirring Paddle Thread Dia. | M12 |
| Net Weight | 3.5kg |

**Features**

Two stirring paddles are optional.

Accessories & Package

Stirring Paddle Assembly, Auxiliary Handle, Carbon Brush, Color Box Packing

DQU05-160**ELECTRIC MIXER**

| | |
|-----------------------------|-----------|
| Rated Power Input | 1800W |
| No-load Speed | 2000r/min |
| Stirring Paddle Dia. | 160mm |
| Stirring Paddle Thread Dia. | M22 |
| Net Weight | 5.5kg |

**Features**

1. 1800W high power;
2. 2000r/min high no-load speed, higher stirring efficiency.

Accessories & Package

Stirring Paddle Assembly (Individually Packed in Carton), Auxiliary Handle, Carbon Brush, Color Box Packing

DQU06-160**ELECTRIC MIXER**

| | |
|-----------------------------|----------|
| Rated Power Input | 2000W |
| No-load Speed | 500r/min |
| Stirring Paddle Dia. | 160mm |
| Stirring Paddle Thread Dia. | M14 |
| Net Weight | 5.1kg |

**Features**

1. 2000W high power;
2. High torque, suitable for thick materials.

Accessories & Package

Stirring Paddle Assembly (Individually Packed in Carton), Auxiliary Handle, Carbon Brush, Color Box Packing

DQU07-160**ELECTRIC MIXER**

| | |
|-----------------------------|------------|
| Rated Power Input | 1400W |
| No-load Speed | 0-680r/min |
| Stirring Paddle Dia. | 160mm |
| Stirring Paddle Thread Dia. | M14 |
| Net Weight | 3.7kg |

**Features**

1. Ergonomic frame handle;
2. Adjustable speed.

Accessories & Package

Stirring Paddle Assembly, Carbon Brush, Open-end Wrench (2pcs), Color Box Packing

DPWG3.0**HIGH-PRESSURE SPRAYING UNIT**

| | |
|-------------------------|----------------|
| Rated Power Input | 1800W |
| No-load Speed | 1440r/min |
| Max. Operating Pressure | 207Bar/3000psi |
| Max. Spray Flow | 3.0L/min |
| Net Weight | 35.0kg |

**Features**

1. Diaphragm type;
2. Brushless motor;
3. Mechanical pressure regulating.

Accessories & Package

Spray Gun (With Nozzle), High-pressure Tube, Extension Tube, Inlet Tube Assembly, Filter Screen, Monkey Wrench, Carton Packing

DPWG2300**HIGH-PRESSURE SPRAYING UNIT**

| | |
|-------------------------|----------------|
| Rated Power Input | 1300W |
| No-load Speed | 5000r/min |
| Max. Operating Pressure | 220Bar/3200psi |
| Max. Spray Flow | 2.3L/min |
| Net Weight | 16.1kg |

**Features**

1. Plunger type;
2. Brushless motor;
3. Intelligent digital display, Electronic pressure regulator.

Accessories & Package

Spray Gun (With Nozzle), High-pressure Tube, Extension Tube, Inlet Tube Assembly, Material Cup (with Screws), Wrench, Hook Wrench, Lubricating Oil, Carton Packing



SPRAY GUN–Pressure Feed (For Use With Diaphragm Pump)



| Model | Standard Nozzle (mm) | Recommended Conditions | | Air Consumption (L/min) | Spraying Width (mm) | Weight (g) |
|-----------|----------------------|---|-------------------------|-------------------------|---------------------|------------|
| | | Operating Pressure MPa (kgf/cm ²) | Max Paint Flow (mL/min) | | | |
| W-71-1.3P | 1.3 | 0.34 (3.5) | 300 | 220 | 260 | 450 |
| W-71-1.5P | 1.5 | 0.34 (3.5) | 400 | 225 | 275 | 450 |
| W-71-1.8P | 1.8 | 0.34 (3.5) | 300 | 220 | 270 | 450 |

Accessories & Package

Wrench, Cleaning Brush, Air Pipe connector, Oil Pipe Connector, Color Box Packing

SPRAY GUN–Gravity Feed



| Model | Standard Nozzle (mm) | Recommended Conditions | | Air Consumption (L/min) | Spraying Width (mm) | Weight (g) |
|-----------|----------------------|---|-------------------------|-------------------------|---------------------|------------|
| | | Operating Pressure MPa (kgf/cm ²) | Max Paint Flow (mL/min) | | | |
| W-71-1.0G | 1.0 | 0.29 (3.0) | 120 | 85 | 120 | 620 |
| W-71-1.3G | 1.3 | 0.29 (3.0) | 160 | 195 | 165 | 620 |
| W-71-1.5G | 1.5 | 0.29 (3.0) | 190 | 230 | 185 | 620 |
| W-71-1.8G | 1.8 | 0.29 (3.0) | 220 | 230 | 230 | 620 |
| W-77-1.8G | 1.8 | 0.34 (3.5) | 320 | 210 | 280 | 750 |
| W-77-2.0G | 2.0 | 0.29 (3.0) | 340 | 370 | 335 | 750 |
| W-77-2.5G | 2.5 | 0.29 (3.0) | 360 | 455 | 350 | 750 |
| W-77-3.0G | 3.0 | 0.29 (3.0) | 380 | 480 | 360 | 750 |

Accessories & Package

Wrench, Cleaning Brush, Air Pipe connector, Oil Pipe Connector, Color Box Packing

SPRAY GUN–Siphon Feed



| Model | Standard Nozzle (mm) | Recommended Conditions | | Air Consumption (L/min) | Spraying Width (mm) | Weight (g) |
|-----------|----------------------|---|-------------------------|-------------------------|---------------------|------------|
| | | Operating Pressure MPa (kgf/cm ²) | Max Paint Flow (mL/min) | | | |
| W-71-1.0S | 1.0 | 0.29 (3.0) | 100 | 85 | 110 | 690 |
| W-71-1.3S | 1.3 | 0.29 (3.0) | 140 | 195 | 155 | 690 |
| W-71-1.5S | 1.5 | 0.29 (3.0) | 170 | 230 | 170 | 690 |
| W-71-1.8S | 1.8 | 0.29 (3.0) | 195 | 230 | 200 | 690 |
| W-77-1.8S | 1.8 | 0.34 (3.5) | 300 | 210 | 270 | 830 |
| W-77-2.0S | 2.0 | 0.29 (3.0) | 340 | 350 | 280 | 830 |
| W-77-2.5S | 2.5 | 0.29 (3.0) | 360 | 435 | 300 | 830 |
| W-77-3.0S | 3.0 | 0.29 (3.0) | 380 | 460 | 320 | 830 |
| W-77-3.5S | 3.5 | 0.34 (3.5) | 480 | 400 | 330 | 830 |

Accessories & Package

Wrench, Cleaning Brush, Air Pipe connector, Oil Pipe Connector, Color Box Packing

DF30

AIR BRAD NAILER

| | |
|------------------------|-----------------|
| Working Pressure | 4-8Bar |
| Inner Dia. of Air Pipe | 8mm |
| Capacity of Magazine | 100pcs |
| Nail Type | Brad Nail |
| Nail Size | Φ1.05x30(max)mm |
| Net Weight | 1.1kg |



Features

1. Narrow nose design;
2. Tool-less depth adjustment;
3. Integrated rubber soft grip.

Accessories & Package

Wrench (2pcs), Lubricating Oil, Color Box Packing

DF50

AIR BRAD NAILER

| | |
|------------------------|---------------------|
| Working Pressure | 5-7Bar |
| Inner Dia. of Air Pipe | 8mm |
| Capacity of Magazine | 100pcs |
| Nail Type | Brad Nail |
| Nail Size | 1.25x1.05x50(max)mm |
| Net Weight | 1.5kg |



Features

1. Narrow nose design;
2. Tool-less depth adjustment;
3. Integrated rubber soft grip.

Accessories & Package

Wrench (2pcs), Lubricating Oil, Color Box Packing

DT50DC

AIR BRAD NAILER

| | |
|------------------------|-------------------|
| Operate Pressure | 4-8Bar |
| Inner Dia. of Air Pipe | 8mm |
| Capacity of Magazine | 100pcs |
| Nails Type | Brad Nail |
| Nails Size | 1.6x1.4x50(max)mm |
| Net Weight | 2.1kg |



Features

1. Narrow nose design;
2. Tool-less depth adjustment;
3. Integrated rubber soft grip.

Accessories & Package

Wrench (2pcs), Lubricating Oil, Color Box Packing

D1013J

AIR STAPLER

| | |
|------------------------|------------------|
| Working Pressure | 4-8Bar |
| Inner Dia. of Air Pipe | 8mm |
| Capacity of Magazine | 100pcs |
| Nail Type | Staple |
| Nail Size | 0.6x10x13(max)mm |
| Net Weight | 0.85kg |



Features

1. Narrow nose design;
2. Tool-less depth adjustment;
3. Integrated rubber soft grip.

Accessories & Package

Wrench (2pcs), Lubricating Oil, Color Box Packing

D1022J

AIR STAPLER

| | |
|------------------------|------------------|
| Working Pressure | 4-8Bar |
| Inner Dia. of Air Pipe | 8mm |
| Capacity of Magazine | 100pcs |
| Nail Type | Staple |
| Nail Size | 0.6x10x22(max)mm |
| Net Weight | 1.1kg |



Features

1. Narrow nose design;
2. Tool-less depth adjustment;
3. Integrated rubber soft grip.

Accessories & Package

Wrench (2pcs), Lubricating Oil, Color Box Packing

D422J

AIR STAPLER

| | |
|------------------------|-----------------|
| Working Pressure | 4-8Bar |
| Inner Dia. of Air Pipe | 8mm |
| Capacity of Magazine | 100pcs |
| Nail Type | Staple |
| Nail Size | 0.6x4x22(max)mm |
| Net Weight | 1.1kg |



Features

1. Narrow nose design;
2. Tool-less depth adjustment;
3. Integrated rubber soft grip.

Accessories & Package

Wrench (2pcs), Lubricating Oil, Color Box Packing

DP625

AIR PIN NAILER

| | |
|------------------------|-----------------|
| Working Pressure | 4-8Bar |
| Inner Dia. of Air Pipe | 8mm |
| Capacity of Magazine | 100pcs |
| Nail Type | Pin Nail |
| Nail Size | Φ0.63x25(max)mm |
| Net Weight | 0.85kg |



Features

1. Narrow nose design;
2. Tool-less depth adjustment;
3. Integrated rubber soft grip.

Accessories & Package

Wrench (2pcs), Lubricating Oil, Color Box Packing

DP630

AIR PIN NAILER

| | |
|------------------------|-----------------|
| Operate Pressure | 4-7Bar |
| Inner Dia. of Air Pipe | 8mm |
| Capacity of Magazine | 100pcs |
| Nail Type | Pin Nail |
| Nail Size | Φ0.64x30(max)mm |
| Net Weight | 0.9kg |



Features

1. Narrow nose design;
2. Tool-less depth adjustment;
3. Integrated rubber soft grip.

Accessories & Package

Wrench (2pcs), Lubricating Oil, Color Box Packing

DST64C**AIR CONCRETE NAILER**

| | |
|------------------------|---------------|
| Working Pressure | 4-8Bar |
| Inner Dia. of Air Pipe | 8mm |
| Capacity of Magazine | 75pcs |
| Nail Type | Steel Nail |
| Nail Size | Φ2.2(18-64)mm |
| Net Weight | 3.0kg |

**Features**

1. Safety switch design;
2. Narrow nose design;
3. Tool-less depth adjustment;
4. Integrated rubber soft grip.

Accessories & Package

Wrench (2pcs), Lubricating Oil, Color Box Packing

**DCN55****AIR COIL NAILER**

| | |
|------------------------|--|
| Operate Pressure | 5-7Bar |
| Inner Dia. of Air Pipe | 8mm |
| Capacity of Magazine | 300pcs |
| Nail Type | Smooth Nail/ Screw Nail/ Plain Nail |
| Nail Size | 25-57(Φ2.1-Φ2.3)mm |
| Net Weight | 2.8kg |

**Features**

1. Tool-free depth adjustments;
2. High capacity canister holds up to 300 nails;
3. Easy-load nail canister system with nail size adjustment base.

Accessories & Package

Goggles, Hex Wrench, Lubricating Oil, Color Box Packing

DCN70**AIR COIL NAILER**

| | |
|------------------------|--|
| Operate Pressure | 6-8Bar |
| Inner Dia. of Air Pipe | 8mm |
| Capacity of Magazine | 300pcs |
| Nail Type | Smooth Nail/ Screw Nail/ Plain Nail |
| Nail Size | 45-70(Φ2.3-Φ2.9)mm |
| Net Weight | 3.6kg |

**Features**

1. Tool-free depth adjustments;
2. High capacity canister holds up to 300 nails;
3. Easy-load nail canister system with nail size adjustment base.

Accessories & Package

Goggles, Hex Wrench (2pcs), Lubricating Oil, Color Box Packing

DQE1608**OIL-FREE AIR COMPRESSOR**

| | |
|-------------------|-----------|
| Rated Power Input | 550W |
| Working Pressure | 7Bar |
| Rated Speed | 1400r/min |
| Capacity | 8L |
| Displacement | ≥32L/min |
| Net Weight | 14.2kg |

**Features**

1. Muting, oil-free;
2. Copper wire motor.

Accessories & Package

Muffler, Foot Pad Assembly (4pcs), Bolt, Nut, Carton Packing

DQE02-1824**OIL-FREE AIR COMPRESSOR**

| | |
|-------------------|-----------|
| Rated Power Input | 750W |
| Working Pressure | 7Bar |
| Rated Speed | 1400r/min |
| Capacity | 24L |
| Displacement | ≥45L/min |
| Net Weight | 17.7kg |

**Features**

1. Muting, oil-free;
2. Copper wire motor.

Accessories & Package

Muffler, Foot Pad Assembly, Wheel Assembly (2pcs), Carton Packing

DQE02-2850**OIL-FREE AIR COMPRESSOR**

| | |
|-------------------|-----------|
| Rated Power Input | 1500W |
| Working Pressure | 7Bar |
| Rated Speed | 1400r/min |
| Capacity | 50L |
| Displacement | ≥95L/min |
| Net Weight | 36.8kg |

**Features**

1. Double air pump design, faster pumping air speed;
2. Muting, oil-free;
3. Copper wire motor.

Accessories & Package

Muffler, Wheel Assembly (4pcs), Carton Packing

DQE1000/12**DOUBLE-TUBE OIL-FREE AIR COMPRESSOR**

| | |
|-------------------|-----------|
| Rated Power Input | 1000W |
| Working Pressure | 7Bar |
| Rated Speed | 1400r/min |
| Capacity | 12L |
| Displacement | 67L/min |
| Net Weight | 18.4kg |

**Features**

1. Double pipe induction;
2. Muting, oil-free;
3. Copper wire motor.

Accessories & Package

Muffler (2pcs), Foot Pad Assembly (4pcs), Carton Packing

DQE1000/24

DOUBLE-TUBE OIL-FREE AIR COMPRESSOR

| | |
|-------------------|-----------|
| Rated Power Input | 1000W |
| Working Pressure | 7Bar |
| Rated Speed | 1400r/min |
| Capacity | 24L |
| Displacement | 67L/min |
| Net Weight | 22.5kg |



Features

1. Double pipe induction;
2. Muting, oil-free;
3. Copper wire motor.

Accessories & Package

Muffler (2pcs), Foot Pad Assembly, Wheel Assembly (2pcs), Carton Packing

DQE1000×2/50

DOUBLE-TUBE OIL-FREE AIR COMPRESSOR

| | |
|-------------------|-----------|
| Rated Power Input | 1000W×2 |
| Working Pressure | 7Bar |
| Rated Speed | 1400r/min |
| Capacity | 50L |
| Displacement | 120L/min |
| Net Weight | 41.5kg |



Features

1. Double air pump design, faster pumping air speed;
2. Muting, oil-free;
3. Copper wire motor.

Accessories & Package

Muffler (4pcs), Foot Pad Assembly (2pcs), Wheel Assembly (2pcs), Carton Packing

DQE1500/12

DOUBLE-TUBE OIL-FREE AIR COMPRESSOR

| | |
|-------------------|-----------|
| Rated Power Input | 1500W |
| Working Pressure | 7Bar |
| Rated Speed | 2800r/min |
| Capacity | 12L |
| Displacement | 100L/min |
| Net Weight | 17.3kg |



Features

1. 1500W high power;
2. Two-pole motor, faster gas injection speed;
3. Double pipe induction;
4. Oil-free.

Accessories & Package

Muffler (2pcs), Foot Pad Assembly (4pcs), Carton Packing

DQE1500/24

DOUBLE-TUBE OIL-FREE AIR COMPRESSOR

| | |
|-------------------|-----------|
| Rated Power Input | 1500W |
| Working Pressure | 7Bar |
| Rated Speed | 2800r/min |
| Capacity | 24L |
| Displacement | 100L/min |
| Net Weight | 19.7kg |



Features

1. 1500W high power;
2. Two-pole motor, faster gas injection speed;
3. Double pipe induction;
4. Oil-free.

Accessories & Package

Muffler (2pcs), Foot Pad Assembly, Wheel Assembly (2pcs), Carton Packing

DQE1008K

DIRECT-DRIVE AIR COMPRESSOR

| | |
|-------------------|-----------|
| Rated Power Input | 750W |
| Working Pressure | 8Bar |
| Rated Speed | 2800r/min |
| Capacity | 8L |
| Displacement | ≥48L/min |
| Net Weight | 14.3kg |



Features

1. Direct connection structure;
2. Faster pumping air speed;
3. Copper wire motor.

Accessories & Package

Muffler (2pcs), Foot Pad Assembly (4pcs), Carton Packing

DQE2524F

DIRECT-DRIVE AIR COMPRESSOR

| | |
|-------------------|-----------|
| Rated Power Input | 1500W |
| Working Pressure | 8Bar |
| Rated Speed | 2800r/min |
| Capacity | 24L |
| Displacement | 100L/min |
| Net Weight | 21.4kg |



Features

1. Direct connection structure;
2. Faster pumping air speed;
3. Copper wire motor.

Accessories & Package

Muffler, Breathing Nozzle, Foot Pad Assembly, Wheel Assembly (2pcs), Carton Packing

DQE3035F

DIRECT-DRIVE AIR COMPRESSOR

| | |
|-------------------|-----------|
| Rated Power Input | 1500W |
| Working Pressure | 8Bar |
| Rated Speed | 2800r/min |
| Capacity | 35L |
| Displacement | 100L/min |
| Net Weight | 26.0kg |



Features

1. Direct connection structure;
2. Faster pumping air speed;
3. Copper wire motor.

Accessories & Package

Muffler, Breathing Nozzle, Foot Pad Assembly, Wheel Assembly (2pcs), Carton Packing





DDF04-40

LASER DISTANCE METER

| | |
|---------------------------------------|------------------|
| Measuring Range | 0.05-40m |
| Accuracy of Measurement | ±1.5mm |
| Laser Diode | 620-650nm, P<1mW |
| Laser Class | 2 |
| Min. Display Unit | 1mm |
| Auto Off (without Operation for) | 180s |
| Battery Life (individual measurement) | 5000 times |
| Battery Specification | 2×1.5V LR03 AAA |
| Working Temperature | -10℃~+50℃ |
| Storage Temperature | -25℃~+70℃ |
| Product Size | 122×46×25mm |
| Net weight | 95g |



Features

1. Distance and area measurement;
2. Data storage.

Accessories & Package

Cloth Carrying Bag, Lanyard, Battery LR03 (2pcs), Color Box Packing

DDF04-60

LASER DISTANCE METER

| | |
|---------------------------------------|------------------|
| Measuring Range | 0.05-60m |
| Accuracy of Measurement | ±1.5mm |
| Laser Diode | 620-650nm, P<1mW |
| Laser Class | 2 |
| Min. Display Unit | 1mm |
| Auto Off (without Operation for) | 180s |
| Battery Life (individual measurement) | 5000 times |
| Battery Specification | 2×1.5V LR03 AAA |
| Working Temperature | -10℃~+50℃ |
| Storage Temperature | -25℃~+70℃ |
| Product Size | 122×46×25mm |
| Net weight | 95g |



Features

1. Distance and area measurement;
2. Data storage.

Accessories & Package

Cloth Carrying Bag, Lanyard, Battery LR03 (2pcs), Color Box Packing

DDF04-80

LASER DISTANCE METER

| | |
|---------------------------------------|------------------|
| Measuring Range | 0.1-80m |
| Accuracy of Measurement | ±1.5mm |
| Laser Diode | 620-650nm, P<1mW |
| Laser Class | 2 |
| Min. Display Unit | 1mm |
| Auto Off (without Operation for) | 180s |
| Battery Life (individual measurement) | 5000 times |
| Battery Specification | 2×1.5V LR03 AAA |
| Working Temperature | -10℃~+50℃ |
| Storage Temperature | -25℃~+70℃ |
| Product Size | 122×46×25mm |
| Net weight | 95g |



Features

1. Distance and area measurement;
2. Data storage.

Accessories & Package

Cloth Carrying Bag, Lanyard, Battery LR03 (2pcs), Color Box Packing

DFF12L

RECHARGEABLE GREEN LASER LEVEL

| | |
|---------------------------------------|-------------------------|
| Power Supply | 4.4Ah 4V Li-Ion battery |
| Laser Diode | 515nm |
| Accuracy | ±0.3mm/m |
| Auto-leveling Range | ±3° |
| Width of Laser Line | 4mm at distance of 10m |
| Operating Temperature | -10~40℃ |
| Running Time (Full Light Normal Mode) | ~6h |
| Net Weight | 0.6kg |
| Laser Class | 3R |



Features

1. Green ray, Lithium battery;
2. Intelligent remote control.

Accessories & Package

Power Adapter, Li-Ion Battery Pack, Remote Device, Rotating Platform, Wall Holder, Suspension Holder, Iron Plate, Carrying Case, Color Box Packing

DFF02-12L

4V

RECHARGEABLE GREEN LASER LEVEL



| | |
|---------------------------------------|-------------------------|
| Power Supply | 4.4Ah 4V Li-Ion battery |
| Laser Diode | 515nm |
| Accuracy | ±0.3mm/m |
| Auto-leveling Range | ±3° |
| Width of Laser Line | 4mm at distance of 10m |
| Operating Temperature | -10~40 °C |
| Running Time (Full Light Normal Mode) | ~6h |
| Net Weight | 0.6kg |
| Laser Class | 3R |



Features

1. Green ray, Lithium battery;
2. Intelligent remote control.
3. Suitable for laying tiles on the floor.

Accessories & Package

Power Adapter, Li-Ion Battery Pack, Remote Device, Rotating Platform, Wall Fixed Holder, Lifting Platform, Iron Plate, Carrying Case, Color Box Packing

DFF06-11S

4V

GREEN LASER LEVEL



| | |
|-----------------------|---------------------------|
| Power Supply | 4400mAh 4V Li-Ion battery |
| Laser Diode | 520nm |
| Vertical Accuracy | 5m±1mm |
| Leveling Accuracy | 5m±1mm |
| Auto-leveling Range | ±3° |
| Leveling Range | ≥120° |
| Vertical Range | ≥120° |
| Width of Laser Line | 2.5mm at distance of 5m |
| Operating Temperature | -10~40 °C |
| Laser Class | 3R |



Function Code:1V 1H

Features

Green light, Lithium battery.

Accessories & Package

Power Adapter, Li-Ion Battery Pack, Suspension Strap, Plastic Carrying Case, Color Box Packing

DFF06-21S

4V

GREEN LASER LEVEL



| | |
|-----------------------|---------------------------|
| Power Supply | 4400mAh 4V Li-Ion battery |
| Laser Diode | 520nm |
| Centering Laser Diode | 650nm |
| Vertical Accuracy | 5m±1mm |
| Leveling Accuracy | 5m±1mm |
| Auto-leveling Range | ±3° |
| Leveling Range | ≥120° |
| Vertical Range | ≥120° |
| Width of Laser Line | 2.5mm at distance of 5m |
| Operating Temperature | -10~40 °C |
| Laser Class | 3R |



Function Code:2V 1H

Features

Green light, Lithium battery.

Accessories & Package

Power Adapter, Li-Ion Battery Pack, Suspension Strap, Plastic Carrying Case, Color Box Packing

DFF06-41S

4V

GREEN LASER LEVEL



| | |
|-----------------------|---------------------------|
| Power Supply | 4400mAh 4V Li-Ion battery |
| Laser Diode | 520nm |
| Centering Laser Diode | 650nm |
| Vertical Accuracy | 5m±1mm |
| Leveling Accuracy | 5m±1mm |
| Auto-leveling Range | ±3° |
| Leveling Range | ≥120° |
| Vertical Range | ≥120° |
| Width of Laser Line | 2.5mm at distance of 5m |
| Operating Temperature | -10~40 °C |
| Laser Class | 3R |



Function Code:4V 1H

Features

Green light, Lithium battery.

Accessories & Package

Power Adapter, Li-Ion Battery Pack, Suspension Strap, Plastic Carrying Case, Color Box Packing

WELDING MACHINE



| DC INVERTER TIG WELDER | | | |
|--------------------------|------------------------------------|------------------------------------|---------|
| Model | TIG-200 | TIG-200A | |
| Power voltage | Single Phase AC220V/AC240V ±15% | Single Phase AC220V/AC240V ±15% | |
| Frequency | 50/60Hz | 50/60Hz | |
| Rated input current | 18A | MMA | TIG |
| | | 20.6A | 18A |
| Output current. | 10~180A | 20~140A | 15~180A |
| Rated output | 17.2V | 25.6V | 17.2V |
| No-load volt. | 42V | 56V | |
| Arc Force adjustment | — | — | |
| Duty cycle | 60% | 60% | |
| No-load loss | 40W | 40W | |
| Efficiency | 85% | 85% | |
| Power factor | 0.73 | 0.73 | |
| Insulation grade | F | F | |
| Dia of Tungsten needle | 1.6mm | 1.6mm | |
| Dia of Welding rod | ----- | 2.5-3.2mm | |
| Housing protection grade | IP21S | IP21S | |
| Weight | 6.5kg | 6.5kg | |
| Arcing way | HF | HF | |

| DC INVERTER TIG WELDER | | |
|------------------------|-------------------------------|-------------------------------|
| Model | MMA160G/ARC160G | MMA200G/ARC200G |
| Power voltage | 1 phase AC220V/AC240V ±15% | 1 phase AC220V/AC240V ±15% |
| Frequency | 50/60Hz | 50/60Hz |
| Rated input current | 20.4A | 24A |
| No-load voltage | 60V | 60V |
| Output current | 30-140A | 30-160A |
| Rated output voltage | 25.6V | 26.4V |
| Duty cycle | 60% | 60% |
| Efficiency | 85% | 85% |
| Power factor | 0.73 | 0.73 |
| Insulation grade | F | F |
| Protection grade | IP21 | IP21 |
| Dia of Welding rod | 2.5-3.2mm | 2.5-3.2mm |
| Weight | 4kg | 4kg |

| DC INVERTER ARC WELDER(MMA) | | | | | |
|-----------------------------|-------------------------------|-------------------------------|-------------------------------|-------------------------------|-------------------------------|
| Model | MMA120/ARC120 | MMA140/ARC140 | MMA160/ARC160 | MMA200/ARC200 | MMA250/ARC250 |
| Input Voltage | 1 phase AC220V/AC240V ±15% | 1 phase AC220V/AC240V ±15% | 1 phase AC220V/AC240V ±15% | 1 phase AC220V/AC240V ±15% | 1 phase AC220V/AC240V ±15% |
| Frequency | 50/60Hz | 50/60Hz | 50/60Hz | 50/60Hz | 50/60Hz |
| Rated Input Current | 17.3A | 20.8A | 24.6A | 30.5A | 55A |
| No-load Voltage | 60V | 60V | 60V | 60V | 60V |
| Output Current | 30-120A | 30-140A | 30-160A | 30-190A | 30-250A |
| Rated Output Current | 24.8V | 25.6V | 26.4V | 27.6V | 30V |
| Current Range(A) | ---- | ---- | ---- | ---- | 0-50 |
| Rated Duty Cycle | 60% | 60% | 60% | 60% | 60% |
| No-load Loss | 40W | 40W | 40W | 40W | 40W |
| Efficiency | 85% | 85% | 85% | 85% | 85% |
| Power Factor | 0.73 | 0.73 | 0.73 | 0.73 | 0.73 |
| Insulation Grade | F | F | F | F | F |
| Housing Protection Grade | IP21 | IP21 | IP21 | IP21 | IP21 |
| Weight | 8kg | 8.7kg | 8.8kg | 9.2kg | 12kg |
| Dimensins(mm) | 455x275x345 | 455x270x345 | 455x270x345 | 455x270x345 | 560x275x360 |

DF3600

GASOLINE GENERATOR

| | |
|-------------------------|--|
| Power | Single-cylinder/4-stroke/Air-cooled 170F |
| Displacement | 208cc |
| Rated Output Voltage | 230V~ |
| Rated Frequency | 50Hz |
| Output Rating | 2800W |
| Continuous Working Time | 11h |
| Net Weight | 45kg |



Features

1. Single-phase electricity output;
2. Manual start.

Accessories & Package

Engine Oil, Oil Funnel, Plug, Tool Kit (Screwdriver, Wrench, Spark Plug Socket Wrench), Carton Packing

DF7500

GASOLINE GENERATOR

| | |
|-------------------------|--|
| Power | Single-cylinder/4-stroke/Air-cooled 190F |
| Displacement | 420cc |
| Rated Output Voltage | 230V~ |
| Rated Frequency | 50Hz |
| Output Rating | 6500W |
| Continuous Working Time | 8h |
| Net Weight | 76kg |



Features

1. Single-phase electricity output;
2. Manual start.

Accessories & Package

Engine Oil, Oil Funnel, Plug (2pcs), Tool Kit (Screwdriver, Wrench, Spark Plug Socket Wrench), Carton Packing

DF9500DSE

GASOLINE GENERATOR

| | |
|-------------------------|--|
| Power | Single-cylinder/4-stroke/Air-cooled 192F |
| Displacement | 438cc |
| Rated Output Voltage | 230V~/400V~ |
| Rated Frequency | 50Hz |
| Output Rating | 7500W |
| Continuous Working Time | 7h |
| Net Weight | 93kg |



Features

1. Single/ Three phase electricity output;
2. Electronic start.

Accessories & Package

Engine Oil, Oil Funnel, Plug (2pcs), Tool Kit (Screwdriver, Wrench, Spark Plug Socket Wrench), Block Terminal, Carton Packing

DQGZ50

GASOLINE WATER PUMP

| | |
|-----------------------|-------------------------------------|
| Power | Single-cylinder/4-stroke/Air-cooled |
| Displacement | 212cc |
| Rated Power | 4.0kW |
| Rated Speed | 3600r/min |
| Input/output Diameter | 50(2") mm |
| Pumping Head | 20m |
| Flow | 20m³/h |
| Self-priming Height | 5m |
| Self-priming Time | ≤140s |
| Net Weight | 25kg |



Features

1. Single cylinder, Four-stroke;
2. Manual start, Forced cooling system.

Accessories & Package

Engine Oil Funnel, Water Filter, Holt Hoop Iron, Outlet & Inlet Water Pipe Connector (2pcs), Screwdriver, Spark Plug Socket Wrench, Carton Packing

DF6500

GASOLINE GENERATOR

| | |
|-------------------------|--|
| Power | Single-cylinder/4-stroke/Air-cooled 170F |
| Displacement | 389cc |
| Rated Output Voltage | 230V~ |
| Rated Frequency | 50Hz |
| Output Rating | 5000W |
| Continuous Working Time | 8h |
| Net Weight | 73kg |



Features

1. Single-phase electricity output;
2. Manual start.

Accessories & Package

Engine Oil, Oil Funnel, Plug (2pcs), Tool Kit (Screwdriver, Wrench, Spark Plug Socket Wrench), Carton Packing

DF9500E

GASOLINE GENERATOR

| | |
|-------------------------|--|
| Power | Single-cylinder/4-stroke/Air-cooled 192F |
| Displacement | 438cc |
| Rated Output Voltage | 230V~ |
| Rated Frequency | 50Hz |
| Output Rating | 7500W |
| Continuous Working Time | 7h |
| Net Weight | 88kg |



Features

1. Single-phase electricity output;
2. Electronic start.

Accessories & Package

Engine Oil, Oil Funnel, Plug (2pcs), Tool Kit (Screwdriver, Wrench, Spark Plug Socket Wrench), Carton Packing



GASOLINE GENERATOR

DQGZ80

GASOLINE WATER PUMP

| | |
|-----------------------|-------------------------------------|
| Power | Single-cylinder/4-stroke/Air-cooled |
| Displacement | 212cc |
| Rated Power | 4.0kW |
| Rated Speed | 3600r/min |
| Input/output Diameter | 80(3") mm |
| Pumping Head | 19m |
| Flow | 30m³/h |
| Self-priming Height | 5m |
| Self-priming Time | ≤160s |
| Net Weight | 30kg |



Features

1. Single cylinder, Four-stroke;
2. Manual start, Forced cooling system.

Accessories & Package

Engine Oil Funnel, Water Filter, Holt Hoop Iron, Outlet & Inlet Water Pipe Connector (2pcs), Screwdriver, Spark Plug Socket Wrench, Carton Packing

Dong Cheng



Outdoor Power
Equipment

D03SSS48

PETROL LAWNMOWER

| | |
|-----------------------------------|------------------|
| Displacement | 160cc |
| Width of Cut | 480mm |
| Power(4-Stroke) | XP160A Zongshen |
| Blade | Flail Blade |
| Max. Torque & Corresponding Speed | 8.1N.m/3000r/min |
| Net Weight | 33.0kg |



Features

1. High strength metal housing;
2. 7 levels of height adjustment.

Accessories & Package

Spark Plug Socket Wrench, Carton Packing

D02YD40

PETROL CHAIN SAW

| | |
|--------------|----------------------|
| Power Input | 1700W |
| Displacement | 39.6mL |
| Power | 2-Stroke Air Cooling |
| Max. Speed | 12500r/min |
| Blade Length | 16" |
| Pitch | 0.325" |
| Net Weight | 4.3kg |



Features

0.325" pitch.

Accessories & Package

Saw Chain, Guide Bar, Bar Protector, Fuel Ratio Oiler, Funnel, Vulnerable Parts (Drawstring, Spark Plug), Tool Bag (Socket Wrench, Screwdriver, Gloves, T-wrench, Goggles, File), Color Box Packing

D02YD45

PETROL CHAIN SAW

| | |
|--------------|----------------------|
| Power Input | 1900W |
| Displacement | 45mL |
| Power | 2-Stroke Air Cooling |
| Blade Length | 18" |
| Pitch | 0.325" |
| Net Weight | 5.0kg |



Features

0.325" pitch.

Accessories & Package

Saw Chain, Guide Bar, Bar Protector, Fuel Ratio Oiler, Funnel, Vulnerable Parts (Drawstring, Spark Plug), Tool Bag (Socket Wrench, Screwdriver, Gloves, T-wrench, Goggles, File), Color Box Packing

D02YD54

PETROL CHAIN SAW

| | |
|--------------|----------------------|
| Power Input | 2300W |
| Displacement | 54.6mL |
| Power | 2-Stroke Air Cooling |
| Max. Speed | 11500r/min |
| Blade Length | 20" |
| Pitch | 0.325" |
| Net Weight | 5.7kg |



Features

0.325" pitch.

Accessories & Package

Saw Chain, Guide Bar, Bar Protector, Fuel Ratio Oiler, Funnel, Vulnerable Parts (Drawstring, Spark Plug), Tool Bag (Socket Wrench, Screwdriver, Gloves, T-wrench, Goggles, File), Color Box Packing

D03YD54

PETROL CHAIN SAW

| | |
|--------------|----------------------|
| Power Input | 2200W |
| Displacement | 54mL |
| Power | 2-Stroke Air Cooling |
| Blade Length | 20" |
| Pitch | 3/8" |
| Net Weight | 5.1kg |



Features

3/8" pitch.

Accessories & Package

Saw Chain, Guide Bar, Bar Protector, Fuel Ratio Oiler, Tool Bag, Inserted Wooden Ruler, Screw with Inserted Wooden Ruler, Paper Pad for Oil Outlet Cover, Socket Wrench, Screwdriver, Hex Wrench T25, Color Box Packing

D03GJB0.7KW

PETROL HEDGE TRIMMER

| | |
|--------------------|----------------------|
| Displacement | 22.5mL |
| Cutting Width | 600mm |
| Power | 2-Stroke Air Cooling |
| Blade Type | Single-edge Tooth |
| Max. Power & Speed | 0.7kW/7500r/min |
| Net Weight | 6.0kg |



Features

1. High quality carburetor, stable quality;
2. Rotatable handle design;
3. Single-edged blade.

Accessories & Package

Blade Protector, Funnel, Lubricating Oil Bottle, Fuel Ratio Oiler, Suspension Straps, Tool Bag (Socket Wrench, Hex Wrench (2pcs), Screwdriver, Open-end Wrench), Carton Packing

D02CXB1.25KW

PETROL BRUSH CUTTER

| | |
|--------------------|----------------------|
| Displacement | 42.7mL |
| Power | 2-Stroke Air Cooling |
| Max. Power & Speed | 1.25kW / 7000r/min |
| Net Weight | 7.9kg |



Features

Single cylinder, Two-stroke, Cooling system.

Accessories & Package

Blade, Rope Sheave, Suspension Straps, Fuel Ratio Oiler, Tool Bag (Socket Wrench, Hex Wrench (2pcs), Open-end Wrench, Gloves), Carton Packing

D02BG431

PETROL BRUSH CUTTER

| | |
|--------------------|----------------------|
| Displacement | 31mL |
| Power | 4-Stroke Air Cooling |
| Max. Power & Speed | 0.7kW / 6500r/min |
| Net Weight | 11.0kg |



Features

1. Single cylinder, Four-stroke, Cooling system;
2. Knapsack;
3. 360° rotatable handle.

Accessories & Package

Blade, Rope Sheave, Measuring Cup, Funnel, Tool Bag (Socket Wrench, Hex Wrench (2pcs), Open-end Wrench, Gloves), Carton Packing

PROFESSIONAL
POWER
TOOLS

Dong Cheng

JIANGSU DONGCHENG M&E TOOLS CO.,LTD.

[Http://www.china-dongcheng.com](http://www.china-dongcheng.com)